

PRO **DECOR**

Inspired by Life

Kolekce úchytek

Kolekcia úchytek

Kolekcja uchwytoów

Fogantyú kollekció

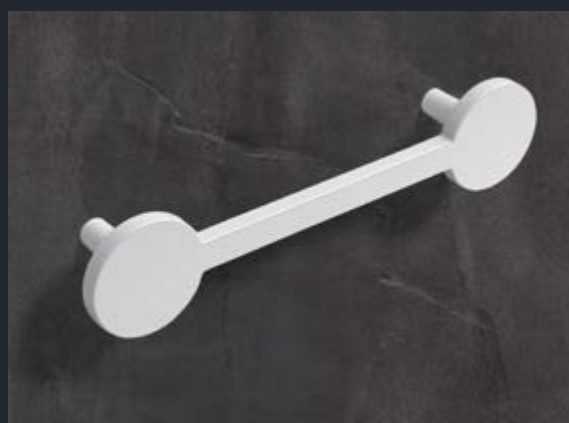

Technik für Möbel

Hettich

ProDecor – Inspired by Life

Přehled | Prehľad | Przegląd | Áttekintés

Piktogramy Piktogramy Legenda Jelmagyarázat

 Délka nebo šířka
Dĺžka alebo šírka
Długość lub szerokość
Hosszúság vagy szélesség

 Výška
Výška
Wysokość
Magasság

 Rozteč vrtání
Vzdialenosť otvorov
Rozstaw nawierceń
Fúrastáv

 Balení
Balenie
Jedn. opakowaniowa
Csomagolási egység

 Ke zkrácení
Na skrátenie
Do samodzielnego przycięcia
Méterre vágható

Všechny rozměry jsou v mm
Všetky rozmery sú v mm
Wszystkie wymiary podane są w mm
Valamenny méret mértékegysége mm

Všechny závitů jsou metrické
Všetky závitů sú metrické
Wszystkie gwinty są metryczne
Valamenny menet metrikus

Při montáži úchytek doporučujeme nepoužívat elektrické nářadí.
Pri montáži úchytkie odporúčame nepoužívať elektrické náradie.
Nie zalecamy używania elektronarzędzi do dokręcania uchwyty.
Javasoljuk, hogy a fogantyú rögzítéséhez ne használjon elektromos szerszámokat.

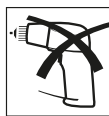

Barva a struktura všech přírodních materiálů se může odlišovat od vyobrazení v katalogu.
Farba a štruktúra všetkých prírodných materiálov sa môže odlišovať od vyobrazenia v katalógu.
Pokazane materiały naturalne mogą w rzeczywistości różnić się kolorem i strukturą.
A természetes anyagok színe és szerkezetét eltérhet a képeken ábrázoltaktól.

Čištění a údržba úchytek:

- ▶ Používejte měkký hadřík, který nepouští vlákna a jemné čističe prostředky rozpustné ve vodě, jako je např. tekuté nebo neutrální mýdlo.
- ▶ Nepoužívejte abraziva, drátěnky, nitro ředidla ani dráždivé nebo žíravé chemikálie, protože by mohly dlouhodobě poškodit povrch!
- ▶ Obecně by nečistoty měly být odstraňovány co nejdříve, aby se zabránilo jejich pronikání do povrchů.

Čistenie a údržba úchytkie:

- ▶ Používejte mäkkú handričku, ktorá neuvolňuje vlákna a jemné čistiace prostriedky rozpustné vo vode, ako je napr. tekuté alebo neutrálné mydlo.
- ▶ Nepoužívajte abrazívne prostriedky, nitro riedidlá ani dráždivé, alebo žieravé chemikálie, pretože by mohli dlhodobo poškodiť povrch!
- ▶ Všeobecne by sa nečistoty mali odstraňovať čo najrýchlejšie, aby sa zabránilo ich prenikaniu do povrchov.

Środki czyszczące do uchwytów i gałek:

- ▶ Używać miękkiej, niestrzępiącej się szmatki oraz rozpuszczalnego w wodzie, delikatnego detergentu, jak mydło w płynie lub mydło neutralne.
- ▶ Nie używać żadnych środków i materiałów ściernych, rozcieńczalników lub żrących / drażniących środków chemicznych, które z czasem mogą uszkodzić powierzchnię!
- ▶ Zabrudzenia należy usuwać możliwie jak najszybciej, aby zapobiec wchłonięciu przez powierzchnię.

Tisztítószert a fogantyúkhöz és a gombokhoz

- ▶ Puha, szármalentes kendőt és vízben oldódó, enyhe tisztítószert, mint például folyékony vagy semleges szappant használjon.
- ▶ Súrolószert/–szivacsot, nitrohígítót vagy maró hatású vegyszereket használni tilos, mert károsíthatják a felületet!
- ▶ A foltokat lehetőség szerint minél gyorsabban távolítsa el, hogy ne ivódhassanak be a felületbe.



Styl NEW MODERN | Štýl NEW MODERN | Styl NEW MODERN | Stílusvilág NEW MODERN

Přehled | Prehľad | Przegląd | Áttekintés
Úchytky | Úchytky | Uchwyty i gałki | Fogantyúk és gombok

4 - 5
6 - 39



Styl DELUXE | Štýl DELUXE | Styl DELUXE | Stílusvilág DELUXE

Přehled | Prehľad | Przegląd | Áttekintés
Úchytky | Úchytky | Uchwyty i gałki | Fogantyúk és gombok

40
42 - 53



Styl ORGANIC | Štýl ORGANIC | Styl ORGANIC | Stílusvilág ORGANIC

Přehled | Prehľad | Przegląd | Áttekintés
Úchytky | Úchytky | Uchwyty i gałki | Fogantyúk és gombok

54 - 55
56 - 57



Styl FOLK | Štýl FOLK | Styl FOLK | Stílusvilág FOLK

Přehled | Prehľad | Przegląd | Áttekintés
Úchytky | Úchytky | Uchwyty i gałki | Fogantyúk és gombok

78 - 79
80 - 101



Touch-in

102

Úchytky | Úchytky | Uchwyty | Fogantyúk

103 - 107



Příslušenství, pomůcky pro zpracování | Príslušenstvo, pomôcky pre spracovanie |
Akcesoria, pomoce montażowe | Tartozékok, segédeszközök
Přehled sortimentu podle materiálů | Prehľad sortimentu podľa materiálů |
Przegląd według materiałów | Áttekintés anyagoként
Rejstřík | Register | Alfabetyczny spis artykułów | Szójjegyzék
Objednací čísla | Objednacie čísla | Wykaz numerów artykułów | Rendelési szám

108 - 119
120 - 124
125
126 - 129

Zařízení interiéru je vyjádřením vkusu jeho majitele. Proto se sortiment ProDecor člení do čtyř kapitol podle stylu: pro bydlení s vyjádřením osobnosti.

Zariadenie interiéru je vyjadrením vkusu jeho majiteľa. Preto sa sortiment ProDecor člení do štyroch kapitol podľa štýlu: pre bývanie s vyjadrením osobnosti.

NEW MODERN



DELUXE



Technické. Strážlivé. Věcné.

Futuristický design a jednoduché, redukované tvary jsou nezaměnitelné znaky úchytek kolekce NEW MODERN. Mistrovsky doplní puristický vzhled nábytku.

Technické. Triezve. Vecné.

Futuristický dizajn a jednoduché, redukované tvary sú nezameniteľné znaky úchytiiek kolekcie NEW MODERN. Majstrovsky dopĺňajú puristický vzhľad nábytku.

Technika. Transparentność. Funkcjonalność.

NEW MODERN zachwyca prostymi liniami, futurystycznym designem oraz chłodną w dotyku powierzchnią. Mistrzowskie dopełnienie minimalistycznych frontów meblowych.

Technika. Átláthatóság. Tárgyilagosság.

A NEW MODERN hatást a világos, futurisztikus formanyelv és nagyszerű tapintás biztosítja. Az egyszerű bútorkomponokat mesteri kialakítása.

Příjemné bydlení – s pocitem luxusu:

Kolekci úchytek DELUXE charakterizují ušlechtilé kovové materiály a majestátní barvy. Jejich energický design vyvolává v interiéru smyslnou atmosféru a svádí k dotyku ...

Příjemné bývanie – s pocitom luxusu:

Kolekciu úchytiiek DELUXE charakterizujú ušľachtilé kovové materiály a majestátne farby. Ich energický dizajn vyvoláva v interiéri zmyselnú atmosféru a zväzda k dotyku ...

Mieszkania pobudzające zmysły – z odrobiną luksusu:

Lśniące metale i majestatyczne kolory definiują styl DELUXE. Wyrazisty design uchwytów tworzy zmysłową atmosferę i zachęca do dotknięcia ...

Érzéki lakások – egy csipetnyi luxussal:

Csillogó fémek és felséges színek jellemzik a DELUXE stílusvilágot. Az erőteljes fogantyú kialakítás érzéki légkört varázsol a helyiségbe, és igényli az érintést ...

Aranżacja wnętrza jest wyrazem osobistego stylu. Dlatego prezentujemy cztery różne style ProDecor: dla wnętrz z charakterem.

A belső elrendezés a személyes stílus kifejezése. Ezért áll rendelkezésre a ProDecor négy stílusvilága: a személyiséggel rendelkező lakásokért.

ORGANIC



FOLK



Idyla nedotčené přírody.

Tato kolekce čerpá tvary z organických forem a povrchy z dotyku drsné přírody. Bydlení s přirozeným půvabem? Vítejte ve stylu ORGANIC!

Idyla nedotknutej přírody.

Táto kolekcia čerpá tvary z organických foriem a povrchy z dotyku drsnej prírody. Bývanie s prirodzeným pôvabom? Vitajte v štýle ORGANIC!

Sielanka nietkniętej natury.

Kolekcja ta odznacza się organicznymi kształtami oraz naturalnymi, surowymi powierzchniami. Mieszkanie z naturalnym urokiem? Witamy w świecie stylu ORGANIC!

Az érintetlen természet idillje.

Ezt a kollekción az organikus formák és a természetesen durva felületek jellemzik. Élne természetesen szép környezetben? Üdvözljük az ORGANIC stílusvilágban!

Úchytky vyprávějí příběhy.

Tradiční tvary a barvy. Bohaté vzory a měkké povrchy lákají k doteku. Rafinovaný vzhled vyžaruje příjemné teplo. FOLK je čiré potěšení. Rovněž pro vaše zákazníky.

Úchytky rozprávajú príbehy.

Tradičné formy a farby. Svieže vzory a mäkké povrchy lákajú k dotyku. Rafinovaný vzhľad vyžaruje príjemné teplo. FOLK je čire potešenie. Taktiež pre vašich zákazníkov.

Uchwyty opowiadające historie.

Tradycyjne kształty i kolory. Bogactwo wzorów oraz miękkie powierzchnie, które dotyka się z przyjemnością. Wyrafinowany „efekt zużycia” emanuje niezwykłym ciepłem. FOLK to czysta radość. Również dla Państwa klientów.

Bútorfogantyúk, amelyek mesélnek.

Hagyományos formák és színek. Gömbölyded kialakítás és puha felület, amit szívesen érintünk. A fényűző hatás kellemes meleget sugároz. A FOLK maga az öröm. A vásárlók számára is.

NEW MODERN



6 Tempe



6 Vigilia



7 Apua



7 Nubia



8 Torino



8 Velitra



9 Capua



9 Imperia



9 Evisa



10 Zenga



11 Bermeo



11 Nursia



12 Cheam



12 Tornea



13 Anzio



13 Arnun



14 Aratti



14 Aosta



15 Clivia



16 Alvito



16 Pola



16 Guarani



16 Narona



17 Hale



18 Salvia



19 Kervo



19 Fermo



20 Stabia



21 Rovigo



22/23 Canis L



24/25 Canis C



26 Celista



26 Genoa



27 Rialto



27 Messana



28 Milo



28 Venusia



29 Trani



29 Ticinum



30 Narni



30 Empoli



35 Genzone



38 Agrinum



31 Lamezia



35 Capris



38 Monacum



32 Lindavia



36 Nidum



39 Danum



32 Lutetia



36 Spira



39 Sion



32 Eslinga



37 Misnia



39 Spalatum



32 Seveso



37 Apolda



33 Mosena



38 Novae



34 Riaza



38 Onex

NEW MODERN

Tempe



Nerezová ocel kartáčovaná
Nerezová ocel kartáčovaná
Stal nierdzewna szcztokowana
Nemesacél, szálcsiszolt

	☐
9 191 722	10

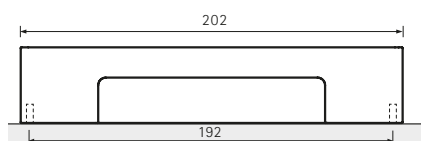

Vigilia



1 Chromovaná lesklá
Chromovaná lesklá
Chrom polysk
Krómozott, fénys



2 Nerezový vzhled kartáčovaný
Nerez finiš kartáčovaný
Imitacja stali nierdzewnej
szcztokowanej
Nemesacél-hatású,
Szálcsiszolt

		☐
1	9 065 627	25
2	9 065 628	25

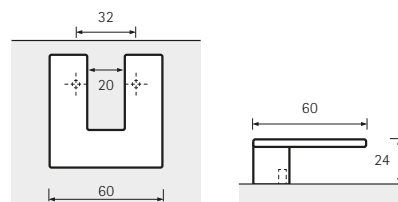

Apua



Nerezový vzhled kartáčovaný
Nerez finiš kartáčovaný
Imitacja stali nierdzewnej
szczotkowanej
Nemesacél-hatású,
Szálcsiszolt

Nubia



1 Chromovaná lesklá
Chrómovaná lesklá
Chrom połysk
Krómozott, fényes



2 Nerezový vzhled kartáčovaný
Nerez finiš kartáčovaný
Imitacja stali nierdzewnej
szczotkowanej
Nemesacél-hatású,
Szálcsiszolt

•••	•	□
160	172	9 112 672 40
224 / 260	272	9 112 674 40
320 / 360	372	9 064 819 25
416 / 460	472	9 064 820 25

	•••	•	□
1	192	245	9 106 166 30
1	256	309	9 106 167 50
1	256	373	9 106 168 25
1	192 / 352	437	9 106 169 25
2	192	245	9 105 837 30
2	256	309	9 105 838 50
2	256	373	9 105 839 25
2	192 / 352	437	9 105 840 25

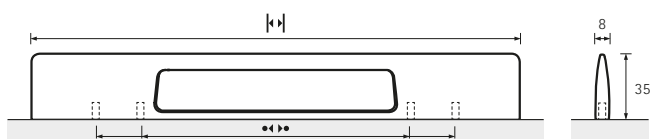
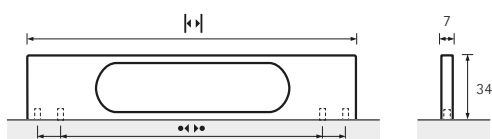

NEW MODERN

Torino



- 1 Chromovaná lesklá
Chrómovaná lesklá
Chrom połysk
Krómozott, fényes



- 2 Nerezový vzhled kartáčovaný
Nerez finiš kartáčovaný
Imitacja stali nierdzewnej
szczotkowanej
Nemesacél-hatású,
Szálcsiszolt

Velitra



- 1 Chromovaná lesklá
Chrómovaná lesklá
Chrom połysk
Krómozott, fényes



- 2 Nerezový vzhled kartáčovaný
Nerez finiš kartáčovaný
Imitacja stali nierdzewnej
szczotkowanej
Nemesacél-hatású,
Szálcsiszolt

	•••	•	□
1	160 / 192	232	9 071 927 50
1	224 / 256	296	9 071 930 50
2	160 / 192	232	9 071 926 50
2	224 / 256	296	9 071 929 50

	•••	•	□
1	128 / 192	204	9 208 551 50
1	224 / 260	272	9 208 578 50
1	260 / 320	372	9 208 579 25
1	360 / 416	472	9 208 580 25
2	128 / 192	204	0 115 018 50
2	224 / 260	272	0 115 014 50
2	260 / 320	372	0 115 016 25
2	360 / 416	472	0 115 017 25

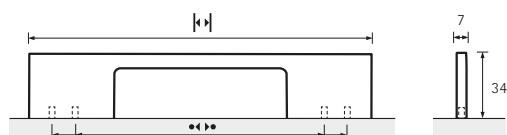
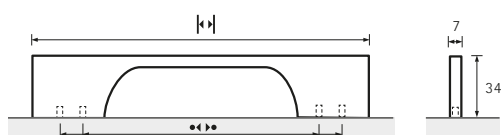

Capua



Nerezový vzhled kartáčovaný
Nerez finiš kartáčovaný
Imitacja stali nierdzewnej
szczotkowanej
Nemesacél-hatású,
Szálcsiszolt

•••	•		□
160	172	9 112 666	40
224 / 260	272	9 112 667	40
320 / 360	372	9 064 670	25
416 / 460	472	9 064 671	25

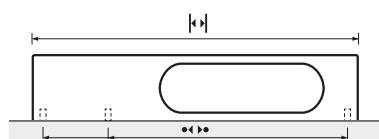

Imperia



Nerezový vzhled kartáčovaný
Nerez finiš kartáčovaný
Imitacja stali nierdzewnej
szczotkowanej
Nemesacél-hatású,
Szálcsiszolt

•••	•		□
192	220	9 995 585	40
224	252	9 995 586	40
320	348	9 995 587	40
448	476	9 995 588	40
541	569	9 995 589	40
560	588	9 995 590	40

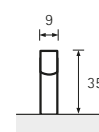
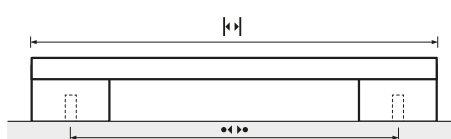

Evisa



1 Chromovaná lesklá
Chrómovaná lesklá
Chrom poľysk
Krómozott, fényes



2 Nerezový vzhled kartáčovaný
Nerez finiš kartáčovaný
Imitacja stali nierdzewnej
szczotkowanej
Nemesacél-hatású,
Szálcsiszolt

		□
1	9 113 501	30
2	9 113 502	30

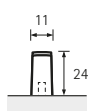
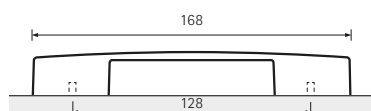

NEW MODERN

Zenga



- 1 Chromovaná lesklá
Chromovaná lesklá
Chrom polysk
Krómozott, fénys



- 3 Chromovaná lesklá
Chromovaná lesklá
Chrom polysk
Krómozott, fénys



- 2 Nerezový vzhled kartáčovaný
Nerez finiš kartáčovaný
Imitácia stali nierdzewnej
szczotkowanej
Nemesacél-hatású,
Szálcsiszolt



- 4 Nerezový vzhled kartáčovaný
Nerez finiš kartáčovaný
Imitácia stali nierdzewnej
szczotkowanej
Nemesacél-hatású,
Szálcsiszolt

		☐
1	9 105 742	25
2	9 105 743	25

		☐
3	9 105 746	25
4	9 105 747	25

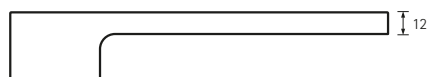
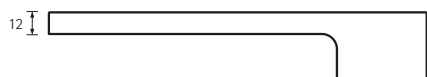
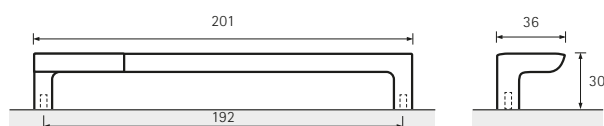
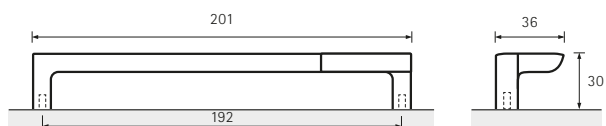

Bermeo



1 Nerezový vzhľad kartáčovaný
Nerez finiš kartáčovaný
Imitácia stali nierdzewnej
szcztokwanej
Nemesacél-hatású,
Szálcsiszolt



2 Černá matná /
nerezový vzhľad kartáčovaný
Čierna matná /
nerez finiš kartáčovaný
Czarny mat /
Imitacja stali nierdzewnej
szcztokwanej
matt fekete /
Nemesacél-hatású,
Szálcsiszolt

Nursia



1 Chromovaná matná
Chrómovaná matná
Chrom mat
Krómozott, matt



2 Nerezový vzhľad kartáčovaný
Nerez finiš kartáčovaný
Imitacja stali nierdzewnej
szcztokwanej
Nemesacél-hatású,
Szálcsiszolt



3 Černá matná
Čierna matná
Czarny mat
Fekete, matt

	•••		□
1	96	109	9 208 073 30
1	128	141	9 208 074 25
1	160	173	9 208 075 25
1	192	205	9 208 076 25
1	224	237	9 208 077 25
1	256	269	9 208 078 50
1	288	301	9 208 079 50
1	320	333	9 208 080 50

2	96	109	9 208 081 30
2	128	141	9 208 082 25
2	160	173	9 208 083 25
2	192	205	9 208 084 25
2	224	237	9 208 085 25
2	256	269	9 208 086 50
2	288	301	9 208 087 50
2	320	333	9 208 088 50

	□
1	9 120 199 25
2	9 112 637 25
3	9 264 087 25

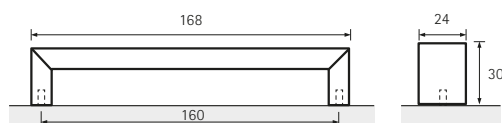
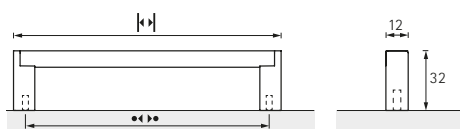

NEW MODERN

Cheam



- 1 Nerezový vzhľad kartáčovaný
Nerez finiš kartáčovaný
Imitácia stali nierzewnej
szczotkowanej
Nemesacél-hatású,
Szálcsiszolt



- 2 Černá matná
Čierna matná
Czarny mat
Matt fekete

Tornea



- 1 Chromovaná lesklá
Chrómovaná lesklá
Chrom połysk
Krómozott, fényes



- 2 Nerezový vzhľad kartáčovaný
Nerez finiš kartáčovaný
Imitácia stali nierzewnej
szczotkowanej
Nemesacél-hatású,
Szálcsiszolt



- 3 Černá matná
Čierna matná
Czarny mat
Matt fekete

	•••	•		□
1	128	163	9 268 262	20
1	160	195	9 268 219	25
1	192	227	9 113 212	20
2	128	163	9 252 428	20
2	160	195	9 252 429	25
2	192	227	9 252 430	20

	•••	•		□
1	128	138	9 112 938	50
1	192	202	9 112 941	50
2	128	138	9 112 940	50
2	192	202	9 112 943	50
3	128	138	9 269 731	50
3	192	202	9 269 732	50

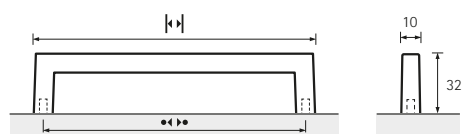
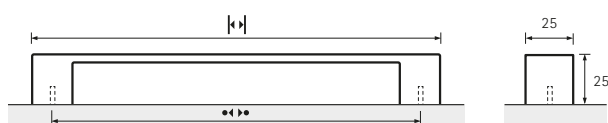

Anzio



Nerezová ocel kartáčovaná
Nerezová ocel kartáčovaná
Stal nierdzewna szczotkowana
Nemesacél, Szálcsiszolt

Arnum



Nerezová ocel kartáčovaná
Nerezová ocel kartáčovaná
Stal nierdzewna szczotkowana
Nemesacél, Szálcsiszolt

•••	k 1	k 2	□
96	106	10	9 204 164 35
128	138	10	1 160 018 30
160	170	10	1 160 019 30
192	202	10	9 204 175 40
224	234	10	1 160 020 50
288	298	10	1 160 021 50
320	330	10	9 204 177 50
352	362	10	1 160 022 50
480	490	10	1 160 023 50
608	618	10	1 160 024 50
736	746	10	1 160 025 50

•••	k 1	k 2	□
160	172	12	9 207 348 40
192	204	12	9 207 356 40
320	332	12	9 207 349 50
416	428	12	9 207 350 40
512	524	12	9 207 351 40
736	748	12	9 207 352 40
832	844	12	9 207 354 40

k	□
10	9 208 071 150
12	9 208 072 150

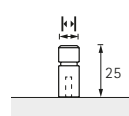
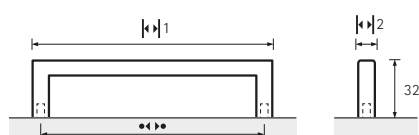

NEW MODERN

Aratti



Nerezová ocel kartáčovaná
Nerezová ocel kartáčovaná
Stal nierdzewna szczotkowana
Nemesacél, Szálcsiszolt

Aosta



Nerezová ocel kartáčovaná
Nerezová ocel kartáčovaná
Stal nierdzewna szczotkowana
Nemesacél, Szálcsiszolt

•••	•	□
96	112	9 113 247 30
128	144	9 069 804 50
160	176	9 069 805 25
192	208	9 069 806 25
224	240	9 069 807 25
256	272	9 113 248 40
320	336	9 069 808 25
352	368	9 113 250 25
384	400	9 113 251 25
416	432	9 113 252 25
480	496	9 207 357 25
584	600	9 113 255 25
684	700	9 113 257 25
784	800	9 113 258 25
984	1000	9 207 358 25

□
9 208 070 150

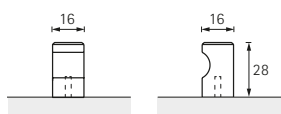

Clivia



1 Hliník eloxovaný
Hliník eloxovaný
Aluminium anodowane
Eloxált aluminium



2 Černá matná
Čierna matná
Czarny mat
Matt fekete

	•••	•		□
1	96	108	0 115 205	50
1	128	140	0 115 355	50
1	160	172	0 115 353	50
1	192	204	0 115 354	50
1	208	220	0 115 215	25
1	224	236	0 115 206	25
1	232	244	0 115 356	50
1	256	268	0 115 207	25
1	282	294	0 115 357	25
1	288	300	0 115 208	25
1	332	344	0 115 358	25
1	352	364	0 115 209	20
1	382	394	0 115 359	25

	•••	•		□
1	416	428	0 115 210	20
1	432	444	0 115 360	25
1	448	460	0 115 211	25
1	482	494	0 115 361	25
1	512	524	0 115 213	25
1	532	544	0 115 362	25
1	544	556	0 115 214	25
1	632	644	0 115 364	25
1	732	744	0 115 363	25
1	2 x 416	844	0 115 212	25
1	2 x 477,5	967	0 115 216	25
1	2 x 564	1140	0 115 217	20
1	2 x 644	1300	0 115 218	20

	•••	•		□
2	96	108	9 265 888	50
2	128	140	9 265 879	50
2	160	172	9 265 880	50
2	192	204	9 265 921	50
2	208	220	9 265 922	25
2	224	236	9 265 923	25
2	232	244	9 265 924	50
2	256	268	9 265 925	25
2	282	294	9 265 926	25
2	288	300	9 265 927	25
2	332	344	9 265 928	25
2	352	364	9 265 929	20
2	382	394	9 265 930	25

	•••	•		□
2	416	428	9 265 931	20
2	432	444	9 265 932	25
2	448	460	9 265 933	25
2	482	494	9 265 934	25
2	512	524	9 265 935	25
2	532	544	9 265 936	25
2	544	556	9 265 937	25
2	632	644	9 265 938	25
2	732	744	9 265 939	25
2	2 x 416	844	9 265 940	25
2	2 x 477,5	967	9 265 941	25
2	2 x 564	1140	9 265 942	20
2	2 x 644	1300	9 265 943	20

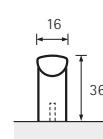
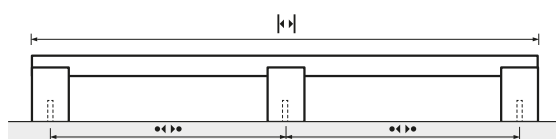

NEW MODERN

Alvito



Chromovaná lesklá
Chromovaná lesklá
Chrom polysk
Krómozott, fényes



•••	•	□
9 113 635	150	

Pola



Nerezová ocel kartáčovaná
Nerezová ocel kartáčovaná
Stal nierdzewna szczotkowana
Nemesacél, Szálcsiszolt

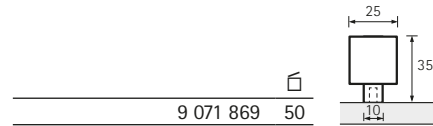

•••	•	□
9 071 869	50	

Guarani



Nerezová ocel kartáčovaná
Nerezová ocel kartáčovaná
Stal nierdzewna szczotkowana
Nemesacél, Szálcsiszolt

•••	•	□
128	149	9 208 046 40
160	181	9 208 047 50
192	223	9 208 048 50
224	259	9 208 049 50

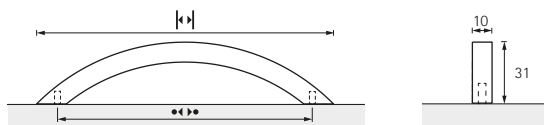

Narona



Nerezová ocel kartáčovaná
Nerezová ocel kartáčovaná
Stal nierdzewna szczotkowana
Nemesacél, Szálcsiszolt

•••	•	□
96	108	9 070 970 50
128	140	9 070 973 25
160	172	9 070 975 40
192	204	9 070 992 40
224	236	9 203 963 40
288	300	9 070 995 50
320	332	9 070 998 50
352	364	9 070 977 25
384	396	9 070 979 25

•••	•	□
480	492	9 071 000 25
640	652	9 071 010 15
736	748	9 071 013 15

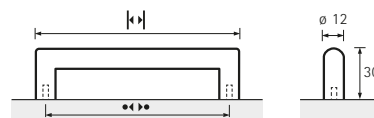

Hale



- 1 Chromovaná lesklá
Chromovaná lesklá
Chrom polysk
Krómozott, fényes

	•••	•		□
1	96	156	9 070 807	20
1	128	188	9 070 809	40
1	160	220	9 070 811	40
1	192	252	9 070 817	40
1	224	284	9 070 821	50
1	288	348	9 070 813	25
1	352	412	9 070 825	25
1	448	508	9 070 803	25
1	480	540	9 070 816	25



- 2 Nerezový vzhled kartáčovaný
Nerez finiš kartáčovaný
Imitácia stali nierdzewnej
szczotkowanej
Nemesacél-hatású,
Szálcsiszolt

	•••	•		□
2	96	156	9 070 674	20
2	128	188	9 070 750	40
2	160	220	9 070 796	40
2	184	244	9 070 746	40
2	192	252	9 070 765	40
2	224	284	9 070 763	50
2	234	294	9 070 742	50
2	284	344	9 070 734	50
2	288	348	9 070 759	25
2	334	394	9 070 733	25
2	352	412	9 070 758	25
2	384	444	9 070 732	25
2	434	494	9 070 736	25
2	448	508	9 070 756	25
2	480	540	9 070 753	25
2	484	544	9 070 738	25
2	784	844	9 070 743	20
2	2 x 453,5	967	9 070 747	15
2	2 x 540	1140	9 070 751	15
2	2 x 620	1300	9 070 755	15



- 3 Černá matná
Čierna matná
Czarny mat
Matt fekete

	•••	•		□
3	96	156	9 306 950	20
3	128	188	9 306 951	40
3	160	220	9 306 952	40
3	192	252	9 306 953	40
3	224	284	9 306 954	50
3	288	348	9 306 955	25
3	352	412	9 306 956	25
3	448	508	9 306 958	25
3	480	540	9 306 959	25

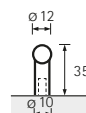
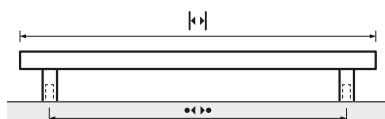

NEW MODERN

Salvia



Nerezová ocel kartáčovaná
Nerezová ocel kartáčovaná
Stal nierdzewna szczotkowana
Nemesacél, Szálcsiszolt

∅10



∅	•••			□
10	96	156	9 070 967	50
10	128	188	9 070 972	50
10	160	220	9 070 978	50
10	192	252	9 070 982	50
10	224	284	9 070 984	75
10	256	316	9 070 988	75
10	288	348	9 070 991	25
10	320	380	9 070 993	20
10	352	412	9 070 996	20
10	384	444	9 070 999	20

∅14



∅	•••			□
14	96	158	9 071 045	50
14	128	188	9 071 046	25
14	160	220	9 071 048	25
14	192	252	9 071 050	25
14	224	284	9 071 051	25
14	256	316	9 071 052	25
14	288	348	9 071 053	25
14	320	380	9 071 054	20
14	352	412	9 071 055	20
14	384	444	9 071 056	20
14	448	508	9 071 058	20
14	480	540	9 071 111	20
14	640	700	9 071 112	15
14	736	796	9 071 115	15
14	2 x 480	1020	9 071 116	15
14	2 x 640	1340	9 071 118	1
14	2 x 720	1500	9 071 120	1

∅12



∅	•••			□
12	96	157	9 071 003	50
12	128	188	9 071 005	50
12	160	220	9 071 008	50
12	192	252	9 071 009	50
12	224	284	9 071 012	50
12	256	316	9 071 017	50
12	288	348	9 071 020	25
12	320	380	9 071 021	20
12	352	412	9 071 023	20
12	384	444	9 071 024	20
12	448	508	9 071 026	20
12	480	540	9 071 027	20
12	640	700	9 071 030	15
12	736	796	9 071 038	15
12	2 x 480	1020	9 071 041	15
12	2 x 640	1340	9 071 042	1
12	2 x 720	1500	9 071 043	1

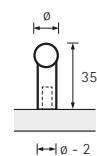
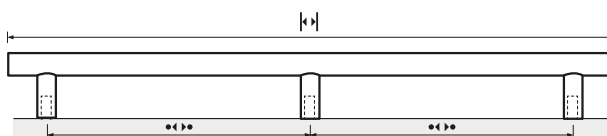

|||∅ - 2

Kervo



- 1 Hliník eloxovaný
Hliník eloxovaný
Aluminium anodowane
Eloxált alumínium



- 2 Černá matná
Čierna matná
Czarny mat
Matt fekete

Fermo



- 1 Chromovaná lesklá
Chrómovaná lesklá
Chrom połysk
Krómozott, fényes



- 2 Nerezový vzhľad kartáčovaný
Nerez finiš kartáčovaný
Imitacja stali nierdzewnej
szcztokowanej
Nemesacél-hatású,
Szálcsiszolt



- 3 Černá matná
Čierna matná
Czarny mat
Matt fekete

	•••	•		□
1	32	56	9 190 436	100
1	64	88	9 194 367	100
1	96 / 128	152	9 190 437	100
1	160 / 192	216	9 190 438	50
1	224 / 256	280	9 190 439	100
1	5 x 224	1100	9 190 440	25
2	32	56	9 190 441	100
2	64	88	9 194 368	100
2	96 / 128	152	9 190 442	100
2	160 / 192	216	9 190 443	50
2	224 / 256	280	9 190 444	100

		□
1	0 115 020	50
2	0 115 019	50
3	9 282 776	50

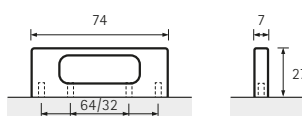
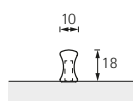
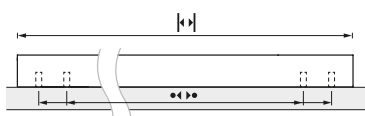

NEW MODERN

Stabia



1 Chromovaná lesklá
Chrómovaná lesklá
Chrom połysk
Krómozott, fényes



3 Nerezový vzhľad kartáčovaný
Nerez finiš kartáčovaný
Imitacja stali nierdzewnej szczot-
kowanej
Nemesacél-hatású,
Szálcsiszolt



2 Hliník eloxovaný
Hliník eloxovaný
Aluminium anodowane
Eloxált aluminium

	«»»	« »	□		«»»	« »	□		
1	64	76	9 209 059	100	3	64	76	9 204 159	100
1	96	108	9 209 060	100	3	96	108	9 204 161	100
1	128	140	9 209 061	50	3	128	140	9 204 162	50
1	160	172	9 209 062	75	3	160	172	9 204 163	75
1	192	204	9 209 063	75	3	192	204	9 204 160	75
1	224	236	9 209 064	50	3	224	236	9 209 058	50
2	64	76	9 204 157	100					
2	96	108	0 115 023	100					
2	128	140	0 115 021	50					
2	160	172	0 115 022	75					
2	192	204	9 204 158	75					
2	224	236	0 115 024	50					
2	13 x 224	2924	9 120 134	8					

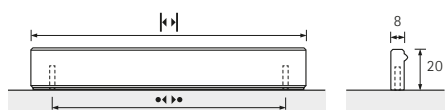

Rovigo



- 1 Chromovaná lesklá
Chrómovaná lesklá
Chrom poľsk
Krómózott, fényes



- 3 Nerezový vzhľad kartáčovaný
Nerez finiš kartáčovaný
Imitácia stali nierdzewnej szczot-
kowanej
Nemesacél-hatású,
Szálcsiszolt



- 2 Hliník eloxovaný
Hliník eloxovaný
Aluminium anodowane
Eloxált alumínium

	«»	«		□
1	64	79	9 204 195	40
1	96	111	9 204 022	35
1	128	143	9 204 023	25
1	160	175	9 113 297	25
1	192	207	9 204 024	25
1	224	239	9 113 299	25
2	64	79	9 204 197	40
2	96	111	9 204 028	35
2	128	143	9 204 029	25
2	160	175	9 204 030	25
2	192	207	9 204 031	25
2	224	239	9 204 032	25
2	8 x 224	2000	9 204 033	8

	«»	«		□
3	64	79	9 204 196	40
3	96	111	9 204 025	35
3	128	143	9 204 026	25
3	160	175	9 113 298	25
3	192	207	9 204 027	25
3	224	239	9 113 300	25

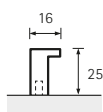

NEW MODERN

Canis L



- 1 Hliník eloxovaný
Hliník eloxovaný
Aluminium anodowane
Eloxált alumínium



- 4 Vnitřní oblouk 90° / aluminium finiš
Vnúťorný oblúk 90° / hliníkový vzhľad
Narožník wewnętrzny 90° /
Imitacja aluminium
Belső sarok 90° / alumíniumhatású



- 2 Nerezový vzhľad
Nerez finiš
Imitacja stali nierdzewnej
Nemesacél-hatású



- 5 Vnitřní oblouk 90° / nerezový vzhľad
Vnúťorný oblúk 90° / nerez finiš
Narožník wewnętrzny 90° /
Imitacja stali nierdzewnej
Belső sarok 90° / nemesacél-hatású



- 3 Černá matná
Čierna matná
Czarny mat
Fekete, matt



- 6 Vnitřní oblouk 90° / černá matná
Vnúťorný oblúk 90° / čierna matná
Narožník wewnętrzny 90° / Czarny mat
Belső sarok 90° / matt fekete

		□	⊙
1	9 210 115	8	⊙
2	9 210 116	8	⊙
3	9 266 104	8	⊙

		□
4	9 210 117	50
5	9 210 119	50
6	9 266 105	50



- 7 Vnější oblouk 90° / aluminium finiš
Vonkajší oblúk 90° / hliníkový vzhľad
Narožník zewnętrzny 90° /
Imitacja aluminium
Külső sarok 90° / alumíniumhatású



- 8 Vnější oblouk 90° / nerezový vzhled
Vonkajší oblúk 90° / nerez finiš
Narožník zewnętrzny 90° /
Imitacja stali nierdzewnej
Külső sarok 90° / nemesacél-hatású



- 9 Vnější oblouk 90° / černá matná
Vonkajší oblúk 90° / čierna matná
Narožník zewnętrzny 90° / Czarny mat
Külső sarok 90° / fekete matt

7	9 210 122	50	
8	9 210 125	50	
9	9 266 106	50	



- 10 Koncovky uzavřené, sada / aluminium finiš
Koncovky uzavreté, sada / hliníkový vzhľad
Zašlepki pełne, zestaw / Imitacja aluminium
Zárt végsapka, készlet / alumíniumhatású



- 11 Koncovky uzavřené, sada / vzhled nerez
Koncovky uzavreté, sada / nerez finiš
Zašlepki pełne, zestaw / Imitacja stali nierdzewnej
Zárt végsapka, készlet / nemesacél-hatású



- 12 Koncovky uzavřené, sada / černá matná
Koncovky uzavreté, sada / čierna matná
Zašlepki pełne, zestaw / Czarny mat
Zárt végsapka, készlet / matt fekete

10	9 210 126	50	
11	9 210 128	50	
12	9 266 107	50	



- 13 Upevňovací úhelník / ocel pozinkovaná
Upevňovací uholník / ocel pozinkovaná
Kątownik mocujący / Stal ocynkowana
Rögzítőkonzol / horganyzott acél



- 14 Upevňovací úhelník zalomený, při použití
koncovek / ocel pozinkovaná
Upevňovací uholník zalomený, pre použitie s
koncovkami / ocel pozinkovaná
Kątownik mocujący wygięty, przy zastosowaniu
zašlepek / Stal ocynkowana
Hajlított rögzítőkonzol, végsapka használat
esetén / horganyzott acél



- 15 Upevňovací úhelník / ocel pozinkovaná
Upevňovací uholník / ocel pozinkovaná
Kątownik mocujący / Stal ocynkowana
Rögzítőkonzol / horganyzott acél

13	9 210 142	100	
14	9 210 143	100	
15	9 210 129	100	

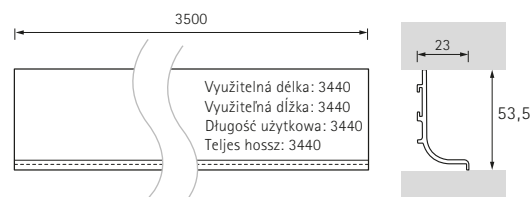

NEW MODERN

Canis C



- 1 Hliník eloxovaný
Hliník eloxovaný
Aluminium anodowane
Eloxált alumínium



- 2 Nerezový vzhľad
Nerez finiš
Imitacja stali nierdzewnej
Nemesacél-hatású



- 3 Černá matná
Čierna matná
Czarny mat
Fekete, matt



- 4 Vnitřní oblouk 90° / aluminium finiš
Vnúťorný oblúk 90° / hliníkový vzhľad
Narožník wewnętrznny 90° /
Imitacja aluminium
Belső sarok 90° / alumíniumhatású



- 5 Vnitřní oblouk 90° / nerezový vzhľad
Vnúťorný oblúk 90° / nerez finiš
Narožník wewnętrznny 90° /
Imitacja stali nierdzewnej
Belső sarok 90° / nemesacél-hatású



- 6 Vnitřní oblouk 90° / černá matná
Vnúťorný oblúk 90° / čierna matná
Narožník wewnętrznny 90° / Czarny mat
Belső sarok 90° / matt fekete

		□	⊙
1	9 210 130	8	⊙
2	9 210 132	8	⊙
3	9 266 132	8	⊙

		□
4	9 210 133	50
5	9 210 136	50
6	9 266 133	50



- 7 Vnější oblouk 90° / aluminium finiš
Vonkajší oblúk 90° / hliníkový vzhľad
Narožník zewnętrzny 90° /
Imitacja aluminium
Külső sarok 90° / alumíniumhatású



- 8 Vnější oblouk 90° / nerezový vzhľad
Vonkajší oblúk 90° / nerez finiš
Narožník zewnętrzny 90° /
Imitacja stali nierdzewnej
Külső sarok 90° / nemesacél-hatású



- 9 Vnější oblouk 90° / černá matná
Vonkajší oblúk 90° / čierna matná
Narožník zewnętrzny 90° / Czarny mat
Külső sarok 90° / fekete matt

7	9 210 138	50	
8	9 210 139	50	
9	9 266 134	50	



- 13 Upevňovací úhelník / ocel pozinkovaná
Upevňovací uholník / ocel pozinkovaná
Kątownik mocujący / Stal ocynkowana
Rögzítőkonzol / horganyzott acél



- 14 Upevňovací úhelník zalomený, při použití
koncovek / ocel pozinkovaná
Upevňovací uholník zalomený, pre použitie s
koncovekami / ocel pozinkovaná
Kątownik mocujący wygięty, przy zastosowaniu
zaślepek / Stal ocynkowana
Hajlított rögzítőkonzol, végsapka használat
esetén / horganyzott acél



- 15 Upevňovací úhelník / ocel pozinkovaná
Upevňovací uholník / ocel pozinkovaná
Kątownik mocujący / Stal ocynkowana
Rögzítőkonzol / horganyzott acél

13	9 210 142	100	
14	9 210 143	100	
15	9 210 129	100	



- 10 Koncovky uzavřené, sada / aluminium finiš
Koncovky uzavreté, sada / hliníkový vzhľad
Zašlepki pełne, zestaw / Imitacja aluminium
Zárt végsapka, készlet / alumíniumhatású



- 11 Koncovky uzavřené, sada / vzhled nerez
Koncovky uzavreté, sada / nerez finiš
Zašlepki pełne, zestaw / Imitacja stali nierdzewnej
Zárt végsapka, készlet / nemesacél-hatású



- 12 Koncovky uzavřené, sada / černá matná
Koncovky uzavreté, sada / čierna matná
Zašlepki pełne, zestaw / Czarny mat
Zárt végsapka, készlet / matt fekete

10	9 210 140	50	
11	9 210 141	50	
12	9 266 135	50	

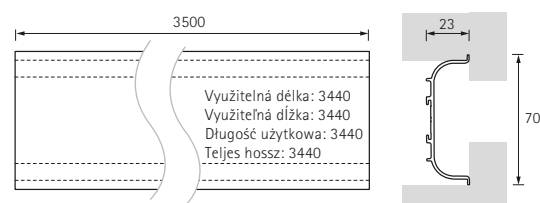

NEW MODERN

Celista



- 1 Bílá
Biela
Biały
Fehér



- 2 Nerezový vzhled kartáčovaný
Nerez finiš kartáčovaný
Imitacja stali nierdzewnej
szcztokowanej
Nemesacél-hatású,
Szálcsiszolt



- 3 Černá matná
Čierna matná
Czarny mat
Fekete, matt

		☐
1	9 082 137	25
2	9 080 838	25
3	9 082 136	25



Genoa



- 1 Chromovaná lesklá
Chrómovaná lesklá
Chrom połysk
Krómozott, fényes



- 2 Nerezový vzhled kartáčovaný
Nerez finiš kartáčovaný
Imitacja stali nierdzewnej
szcztokowanej
Nemesacél-hatású,
Szálcsiszolt

		☐
1	9 065 611	30
2	9 065 612	30

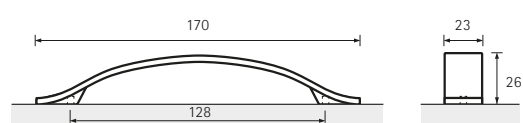

Rialto



- 1 Chromovaná lesklá
Chrómovaná lesklá
Chrom poľysk
Krómozott, fényses



- 2 Nerezový vzhľad kartáčovaný
Nerez finiš kartáčovaný
Imitácia stali nierdzewnej
szczotkowanej
Nemesacél-hatású,
Szálcsiszolt



- 3 Černá matná
Čierna matná
Czarny mat
Fekete, matt

Messana



- 1 Chromovaná lesklá
Chrómovaná lesklá
Chrom poľysk
Krómozott, fényses



- 2 Nerezový vzhľad kartáčovaný
Nerez finiš kartáčovaný
Imitácia stali nierdzewnej
szczotkowanej
Nemesacél-hatású,
Szálcsiszolt

1	9 097 953	25	
2	9 097 950	25	
3	9 264 086	25	

1	0 115 157	50	
2	0 115 156	50	

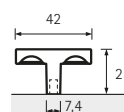
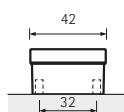
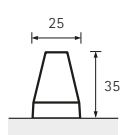
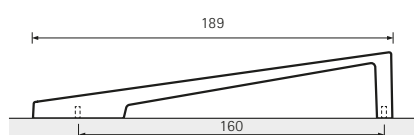

NEW MODERN

Milo



1 Chromovaná lesklá
Chrómovaná lesklá
Chrom poľysk
Krómozott, fényes



2 Nerezový vzhľad kartáčovaný
Nerez finiš kartáčovaný
Imitacja stali nierdzewnej
szcótkowanej
Nemesacél-hatású,
Szálcsiszolt

			☐
1	9 105 793	100	
2	9 105 794	100	

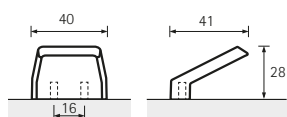

Venusia



1 Chromovaná lesklá
Chrómovaná lesklá
Chrom poľysk
Krómozott, fényes



2 Nerezový vzhľad kartáčovaný
Nerez finiš kartáčovaný
Imitacja stali nierdzewnej
szcótkowanej
Nemesacél-hatású,
Szálcsiszolt

			☐
1	0 115 155	25	
2	0 115 154	25	

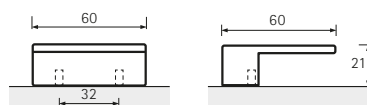

Trani



1 Hliník eloxovaný
Hliník eloxovaný
Aluminium anodowane
Eloxált alumínium



2 Černá matná
Čierna matná
Czarny mat
Matt fekete

Ticinum



1 Hliník eloxovaný
Hliník eloxovaný
Aluminium anodowane
Eloxált alumínium



2 Černá matná
Čierna matná
Czarny mat
Matt fekete

	•••			□
1	32	52	9 995 437	60
1	64	84	9 995 438	50
1	96	116	9 995 439	50
1	128	148	9 995 440	25
2	32	52	9 265 949	60
2	64	84	9 265 950	50
2	96	116	9 265 971	50
2	128	148	9 265 972	25

	•••			□
1	32	50	9 070 583	75
1	50	70	9 070 588	75
1	70	90	9 070 593	50
1	8x224	2000	9 131 455	12
2	32	50	9 306 227	75
2	50	70	9 306 228	75
2	70	90	9 306 229	50

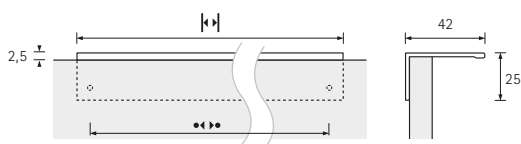
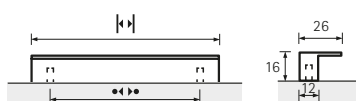

NEW MODERN

Narni



Nerezová ocel kartáčovaná
Nerezová ocel kartáčovaná
Stal nierdzewna szczotkowana
Nemesacél, Szálcsiszolt

•••	••		□
20	30	9 995 574	75
50	60	9 158 400	50
80	90	9 206 741	50

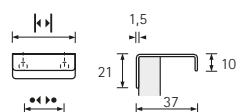

Empoli



1 Chromovaná lesklá
Chrómovaná lesklá
Chrom polysk
Krómozott, fényes



2 Chromovaná matná
Chrómovaná matná
Chrom mat
Krómozott, matt



3 Nerezový vzhľad kartáčovaný
Nerez finiš kartáčovaný
Imitacja stali nierdzewnej
szczotkowanej
Nemesacél-hatású,
Szálcsiszolt

		□
1	9 995 541	70
2	9 995 540	70
3	9 995 542	70

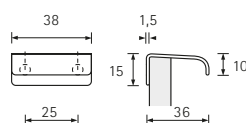

Lamezia



- 1 Chromovaná lesklá
Chromovaná lesklá
Chrom polysk
Krómozott, fényes



- 2 Hliník eloxovaný
Hliník eloxovaný
Aluminium anodowane
Eloxált aluminium



- 3 Nerezový vzhľad kartáčovaný
Nerez finiš kartáčovaný
Imitacja stali nierdzewnej
szcztokowanej
Nemesacél-hatású,
Szálcsiszolt



- 4 Černá matná
Čierna matná
Czarny mat
Matt fekete



- 5 Zlatý vzhľad, matně kartáčovaný
Zlatý vzhľad, matný kartáčovaný
Imitacja złota szcztokowanego mat
Aranyhatású, matt, kefélt

	∣∣		□
1	295	9 105 801	50
1	345	9 105 802	25
1	395	9 105 803	25
1	445	9 105 805	25
1	495	9 105 806	25
1	595	9 105 807	25
1	795	9 105 809	25
1	895	9 105 810	25
1	995	9 105 811	25
1	1195	9 105 813	20
<hr/>			
2	295	9 105 827	50
2	345	9 105 828	25
2	395	9 105 829	25
2	445	9 105 830	25
2	495	9 105 831	25
2	595	9 105 832	25
2	795	9 105 833	25
2	895	9 105 834	25
2	995	9 105 835	25
2	1195	9 105 836	20
<hr/>			
3	295	9 105 815	50
3	345	9 105 816	25
3	395	9 105 819	25
3	445	9 105 820	25
3	495	9 105 821	25
3	595	9 105 822	25
3	795	9 105 823	25
3	895	9 105 824	25
3	995	9 105 825	25
3	1195	9 105 826	20
<hr/>			
4	295	9 265 973	50
4	345	9 265 975	25
4	395	9 265 976	25
4	445	9 265 977	25
4	495	9 265 978	25
4	595	9 265 979	25
4	795	9 265 980	25
4	895	9 265 981	25
4	995	9 265 982	25
4	1195	9 265 983	20
<hr/>			
5	295	9 265 985	50
5	345	9 265 986	25
5	395	9 265 987	25
5	445	9 265 988	25
5	495	9 265 989	25
5	595	9 265 990	25
5	795	9 265 991	25
5	895	9 265 992	25
5	995	9 265 993	25
5	1195	9 265 994	20

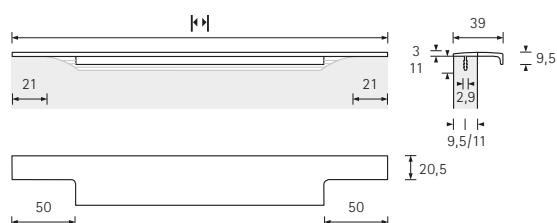

NEW MODERN

Lindavia



Hliník eloxovaný
Hliník eloxovaný
Aluminium anodowane
Eloxált aluminium

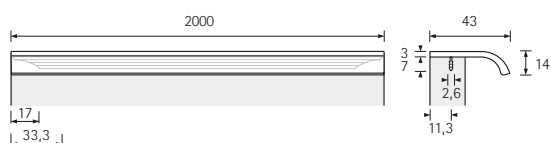
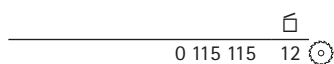

Lutetia



Hliník eloxovaný
Hliník eloxovaný
Aluminium anodowane
Eloxált aluminium

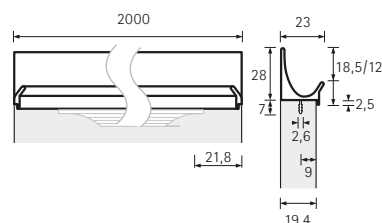
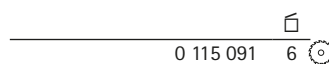

Eslinga



Hliník eloxovaný
Hliník eloxovaný
Aluminium anodowane
Eloxált aluminium

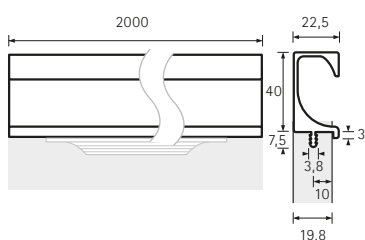
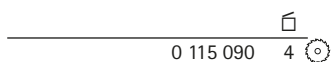

Seveso



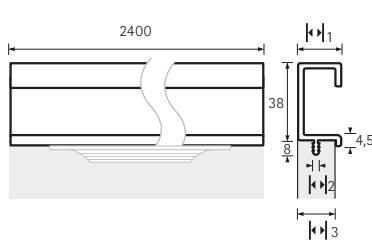
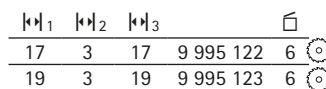

Hliník eloxovaný
Hliník eloxovaný
Aluminium anodowane
Eloxált aluminium



Mosena



Hliník eloxovaný
 Hliník eloxovaný
 Aluminium anodowane
 Eloxált alumínium

9 237 970 10  

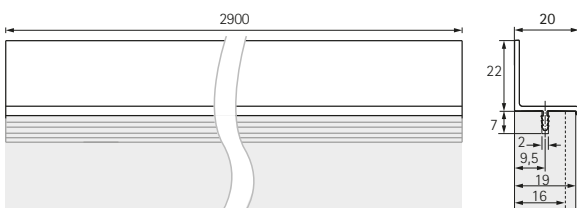

NEW MODERN

Riaza



- 1 Hliník eloxovaný
Hliník eloxovaný
Aluminium anodowane
Eloxált alumínium



- 2 Nerezový vzhľad kartáčovaný
Nerez finiš kartáčovaný
Imitacja stali nierdzewnej
szczotkowanej
Nemesacél-hatású,
Szálcsiszolt



- 3 Černá matná
Čierna matná
Czarny mat
Matt fekete

			□
1	295	9 208 097	30
1	395	9 208 098	20
1	445	9 208 099	20
1	495	9 208 100	20
1	595	9 208 101	20
1	795	9 208 102	20
1	895	9 208 103	20
1	2400	9 266 102	6

2	295	9 208 089	30
2	395	9 208 090	20
2	445	9 208 091	20
2	495	9 208 092	20
2	595	9 208 093	20
2	795	9 208 094	20
2	895	9 208 095	20

3	295	9 266 095	30
3	395	9 266 096	20
3	445	9 266 097	20
3	495	9 266 098	20
3	595	9 266 099	20
3	795	9 266 100	20
3	895	9 266 101	20

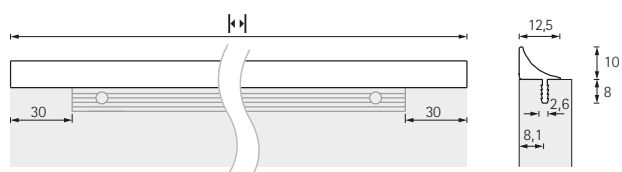

Genzone



- 1 Chromovaná lesklá
Chromovaná lesklá
Chrom poľusk
Krómózott, fényes



- 2 Nerezový vzhľad kartáčovaný
Nerez finiš kartáčovaný
Imitácia stali nierdzewnej
szczotkowanej
Nemesacél-hatású,
Szálcsiszolt

Capris



- 1 Hliník eloxovaný
Hliník eloxovaný
Aluminium anodowane
Eloxált aluminium



- 2 Nerezový vzhľad
Nerez finiš
Imitácia stali nierdzewnej
Szczotkowanej
nemesacél-hatású



- 3 Koncovky, sada / aluminium finiš
Koncovky, sada / hliníkový vzhľad
Zestaw zaślepek / Imitacja aluminium
Végsapka-készlet / alumíniumhatású



- 4 Koncovky, sada / vzhľad niklovaný matný
Koncovky, sada / vzhľad niklovaný matný
Zestaw zaślepek / Imitacja nikiel mat
Végsapka-készlet / nikkelezett, matt hatású

1	9 145 262	50	
2	9 145 263	50	

1	9 149 293	8	
2	9 149 296	8	
3	0 115 028	50	
4	0 115 049	50	

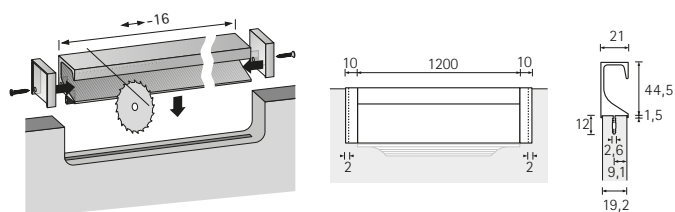
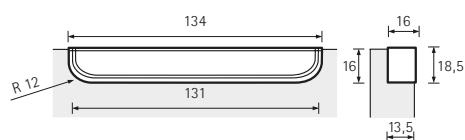

NEW MODERN

Nidum



Aluminium finiš
Hliníkový vzhľad
Imitácia aluminium
Alumíniumhatású

Spira



1 Hliník eloxovaný
Hliník eloxovaný
Aluminium anodowane
Eloxált aluminium



2 Koncovky, sada / aluminium finiš
Koncovky, sada / hliníkový vzhľad
Zestaw zaślepek / Imitacja aluminium
Végsapka-készlet / alumíniumhatású

•••	••• ₁	••• ₂		□
96	111	107	9 071 060	25
128	143	139	9 071 071	25
160	175	171	9 071 073	25
192	207	203	9 071 075	25
256	271	267	9 071 079	50
320	335	331	9 071 082	50

		□	○
1	0 115 314	6	
2	0 115 298	100	

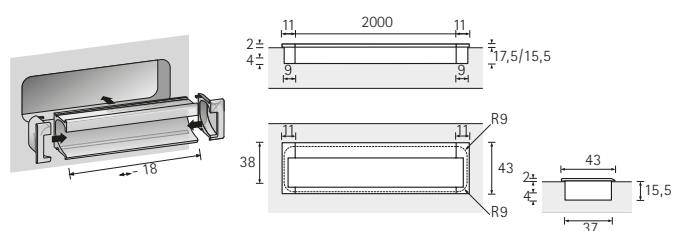
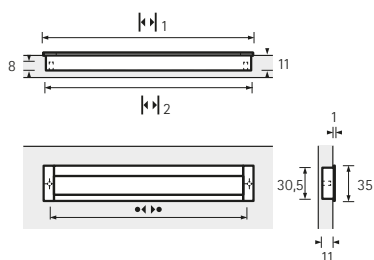

Misnia



- 1 Aluminium finiš
Hliníkový vzhľad
Imitácia aluminium
Alumíniumhatású



- 2 Vzhľad niklovaný matný
Vzhľad niklovaný matný
Imitácia nikel mat
Nikkelezett, matt hatású

Apolda



- 1 Nerezová ocel kartáčovaná
Nerezová ocel kartáčovaná
Stal nierdzewna szczotkowana
Nemesacél, Szálcsiszolt



- 2 Nerezová ocel kartáčovaná / černá lesklá
Nerezová ocel kartáčovaná / čierna lesklá
Stal nierdzewna szczotkowana / Czarny połysk
Nemesacél, Szálcsiszolt /
feketén csillogó

	•••	••• ₁	••• ₂		□
1	96	116	111	0 115 181	50
1	160	180	176	0 115 127	25
2	96	116	111	0 115 182	50
2	160	180	176	0 115 183	25

		□
1	9 191 745	20
2	9 207 531	20

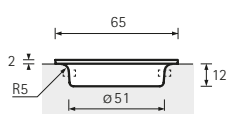
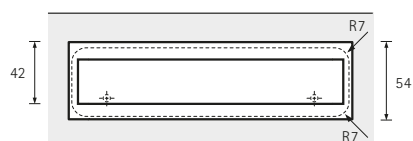
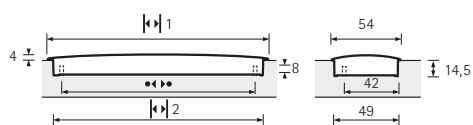

NEW MODERN

Novae



1 Chromovaná lesklá
Chrómovaná lesklá
Chrom polysk
Krómozott, fényes

2 Niklovaná matná
Niklovaná matná
Nikiel mat
Nikkelezett, matt

	Ø	H	Q	Q
1	19	28	9 112 634	100
2	14,5	28	9 112 633	100

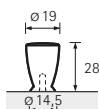

Onex



Nerezová ocel kartáčovaná
Nerezová ocel kartáčovaná
Stal nierdzewna szczotkowana
Nemesacél, Szálcsiszolt

	Ø	H	Q	Q
	22	30	9 113 565	100

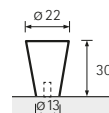

Agrinum



Nerezová ocel kartáčovaná
Nerezová ocel kartáčovaná
Stal nierdzewna szczotkowana
Nemesacél, Szálcsiszolt

Ø	H	Q	Q
14	22	9 070 263	200
18	26	9 070 264	125



Monacum



Nerezová ocel kartáčovaná
Nerezová ocel kartáčovaná
Stal nierdzewna szczotkowana
Nemesacél, Szálcsiszolt

Ø	H	Q	Q
10	22	9 070 957	200
14	26	9 070 958	150



DELUXE



42 Amisia



42 Limpio



43 Istrana



43 Itri



44 Forli



44 Brema



45 Como



45 Utinum



46 Baldone



46 Belluno



47 Cecina



47 Ponte



48 Intra



49 Veronia



49 Basilia



50 Arimini



50 Opera



50 Saturnia



51 Delia



51 Lodi



51 Sava



52 Solda



52 Londa



53 Fogo



53 Bona



DELUXE

DELUXE

Amisia



- 1 Chromovaná lesklá
Chrómovaná lesklá
Chrom połysk
Krómozott, fényes



- 2 Nerezový vzhľad kartáčovaný
Nerez finiš kartáčovaný
Imitacja stali nierdzewnej szczotkowanej
nemesacél-hatású,
Szálcsiszolt

1	9 190 446	25	
2	9 190 445	25	

Limpio



- 1 Bílá matná
Biela matná
Biały mat
Matt fehér



- 2 Černá matná
Čierna matná
Czarny mat
Matt fekete

1	9 266 417	25	
2	9 266 418	25	

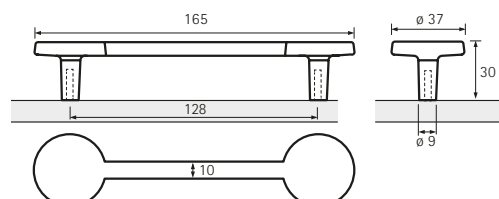
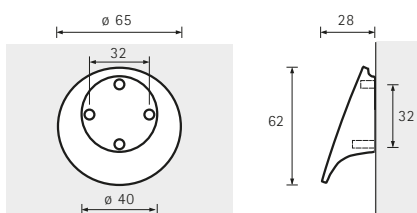

Istrana



Nerezový vzhled kartáčovaný
Nerez finiš kartáčovaný
Imitacja stali nierdzewnej szczotkowanej
Nemesacél-hatású,
Szálcsiszolt

Itri



Nerezový vzhled kartáčovaný
Nerez finiš kartáčovaný
Imitacja stali nierdzewnej szczotkowanej
Nemesacél-hatású,
Szálcsiszolt

DELUXE

9 132 312 25

9 132 314 30

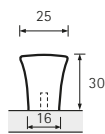
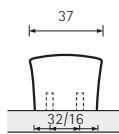
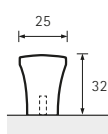
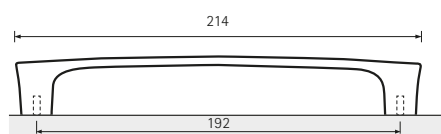

DELUXE

Forli



- 1 Chromovaná lesklá
Chrómovaná lesklá
Chrom poľsk
Krómózott, fényes



- 2 Nerezový vzhľad kartáčovaný
Nerez finiš kartáčovaný
Imitácia stali nierdzewnej szczotkowanej
Nemesacél-hatású,
Szálcsiszolt

		☐
1	9 112 660	35
2	9 207 488	35

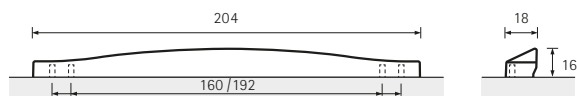

Brema



- 1 Nerezová oceľ kartáčovaná /
nerezový vzhľad kartáčovaný
Nerezová oceľ kartáčovaná/
nerez finiš kartáčovaný
Stal nierdzewna szczotkowana /
Imitacja stali nierdzewnej szczotkowanej
Nemesacél, Szálcsiszolt /
nemesacél-hatású, Szálcsiszolt



- 2 Černá matná /
nerezový vzhľad kartáčovaný
Čierna matná / nerez finiš kartáčovaný
Czarny mat /
Imitacja stali nierdzewnej szczotkowanej
Matt fekete /
Nemesacél-hatású, Szálcsiszolt

	☐	☐	☐		☐
1	96	108	9 118 858	25	2
1	128	140	9 069 890	25	2
1	160	172	9 069 893	25	2
1	192	204	9 070 104	25	2
1	224	236	9 070 106	25	2
1	256	268	9 070 107	30	2
1	288	300	9 070 108	30	2
1	352	364	9 070 109	20	2
1	416	428	9 070 110	20	2
1	448	460	9 070 112	20	2
1	640	652	9 070 113	15	2

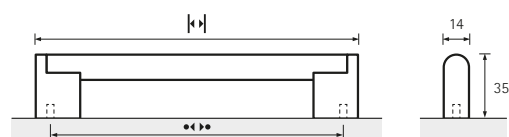

Como



- 1 Nerezová ocel kartáčovaná /
nerezový vzhľad kartáčovaný
Nerezová oceľ kartáčovaná /
nerez finiš kartáčovaný
Stal nierdzewna szcztkowana /
Imitacja stali nierdzewnej szcztkowanej
Nemesacél, Szálcsiszolt /
nemesacél-hatású, Szálcsiszolt



- 2 Černá matná
Čierna matná
Czarny mat
Matt fekete

Utinum



- Nerezový vzhľad kartáčovaný
Nerez finiš kartáčovaný
Imitacja stali nierdzewnej szcztkowanej
Nemesacél-hatású,
Szálcsiszolt

	•••			□
1	192	204	0 115 077	25
1	320	332	0 115 078	20
2	192	204	9 264 072	25
2	320	332	9 264 073	20

	□
	9 109 703 50

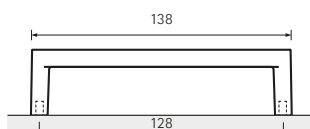
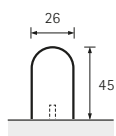

DELUXE

Baldone



1 Chromovaná lesklá
Chrómovaná lesklá
Chrom połysk
Krómozott, fényes



2 Chromovaná matná
Chrómovaná matná
Chrom mat
Krómozott, matt



3 Nerezový vzhľad kartáčovaný
Nerez finiš kartáčovaný
Imitacja stali nierdzewnej szczotkowanej
Nemesacél-hatású, Szálcsiszolt



4 Černá matná
Čierna matná
Czarny mat
Matt fekete

	•••	k ₁	k ₂	±	□
1	96	104	11	26	9 995 546 40
1	128	136	11	26	9 995 547 30
1	160	168	11	26	9 995 780 30
1	256	264	15	29	9 995 548 25
2	96	104	11	26	9 995 482 40
2	128	136	11	26	9 995 480 30
2	160	168	11	26	9 995 782 30
2	256	264	15	29	9 995 484 25
3	96	104	11	26	9 995 483 40
3	128	136	11	26	9 995 481 30
3	160	168	11	26	9 995 781 30
3	256	264	15	29	9 995 485 25
4	96	104	11	26	9 269 733 40
4	128	136	11	26	9 269 734 30
4	160	168	11	26	9 269 735 30
4	256	264	15	29	9 269 736 25

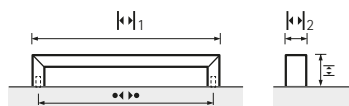

Belluno



1 Chromovaná lesklá
Chrómovaná lesklá
Chrom połysk
Krómozott, fényes



2 Chromovaná matná
Chrómovaná matná
Chrom mat
Krómozott, matt



3 Nerezový vzhľad kartáčovaný
Nerez finiš kartáčovaný
Imitacja stali nierdzewnej szczotkowanej
Nemesacél-hatású, Szálcsiszolt



4 Černá matná
Čierna matná
Czarny mat
Matt fekete

	•••	k ₁	±	□
1	96	130	28	0 043 643 30
1	160 / 192	200	30	0 043 503 40
1	224 / 256	267	30	0 043 506 25
2	96	130	28	0 043 642 30
2	160 / 192	200	30	0 043 502 40
2	224 / 256	267	30	0 043 505 25
3	96	130	28	9 995 771 30
3	160 / 192	200	30	9 995 772 40
3	224 / 256	267	30	9 995 773 25
4	96	130	28	9 270 437 30
4	160 / 192	200	30	9 270 438 40
4	224 / 256	267	30	9 270 439 25

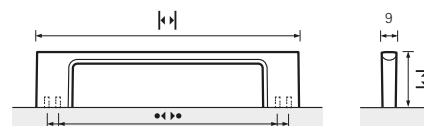

Cecina



1 Šampaň / nerezová ocel kartáčovaná
Šampaň / nerezová ocel kartáčovaná
Szampański /
Stal nierdzewna szczotkowana
Pezsgő / nemesacél, Szálcsiszolt



2 Červená / nerezová ocel kartáčovaná
Červená / nerezová ocel kartáčovaná
Czerwony /
Stal nierdzewna szczotkowana
Piros / nemesacél, Szálcsiszolt



3 Modrá / nerezová ocel kartáčovaná
Modrá / nerezová ocel kartáčovaná
Niebieski /
Stal nierdzewna szczotkowana
Kék / nemesacél, Szálcsiszolt



4 Antracit / nerezová ocel kartáčovaná
Antracit / nerezová ocel kartáčovaná
Antracytowy /
Stal nierdzewna szczotkowana
Antracit / nemesacél,
Szálcsiszolt

Ponte



Nerezová ocel kartáčovaná
Nerezová ocel kartáčovaná
Stal nierdzewna szczotkowana
Nemesacél, Szálcsiszolt

		☐
1	9 199 093	10
2	9 199 030	10
3	9 199 091	10
4	9 199 092	10

•••		☐
160	173	0 115 385 25
192	205	0 115 060 50
320	333	0 115 387 20

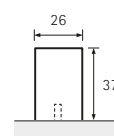
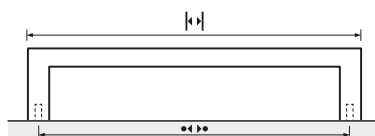
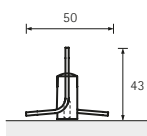
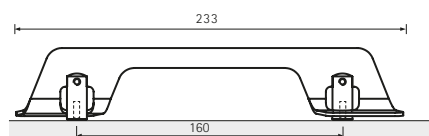

DELUXE

Intra



- 1 Chromovaná lesklá / chromovaná matná
Chrómovaná lesklá / chrómovaná matná
Chrom poľsk / Chrom mat
Krómozott, fényes / krómozott, matt



- 2 Chromovaná matná / chromovaná lesklá
Chrómovaná matná / chrómovaná lesklá
Chrom mat / Chrom poľsk
Krómozott, matt / krómozott, fényes



- 3 Nerezový vzhľad kartáčovaný / chromovaná lesklá
Nerez finiš kartáčovaný / chrómovaná lesklá
Imitacja stali nierdzewnej szczotkowanej / Chrom poľsk
Nemesacél-hatású, Szálcsiszolt / krómozott, fényes



- 4 Nerezový vzhľad kartáčovaný
Nerez finiš kartáčovaný
Imitacja stali nierdzewnej szczotkowanej
Nemesacél-hatású, Szálcsiszolt



- 5 Nerezový vzhľad kartáčovaný / miedňový vzhľad kartáčovaný
Nerez finiš kartáčovaný / medený vzhľad kartáčovaný
Imitacja stali nierdzewnej szczotkowanej / Imitacja miedzi szczotkowanej
Nemesacél-hatású, Szálcsiszolt / rézhatású, Szálcsiszolt



- 6 Bílá matná / miedňový vzhľad kartáčovaný
Biela matná / medený vzhľad kartáčovaný
Biały mat / Imitacja miedzi szczotkowanej
Matt fehér / rézhatású, Szálcsiszolt



- 7 Černá matná / nerezový vzhľad kartáčovaný
Čierna matná / nerez finiš kartáčovaný
Czarny mat / Imitacja stali nierdzewnej szczotkowanej
Matt fekete / nemesacél-hatású, Szálcsiszolt



- 8 Černá matná / miedňový vzhľad kartáčovaný
Čierna matná / medený vzhľad kartáčovaný
Czarny mat / Imitacja miedzi szczotkowanej
Matt fekete / rézhatású, Szálcsiszolt

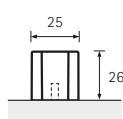
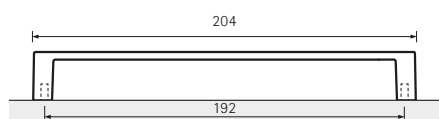

		☐		☐
1	9 113 800	25	5	9 207 480 25
2	9 105 737	25	6	9 207 483 25
3	9 105 735	25	7	9 207 481 25
4	9 207 482	25	8	9 264 088 25

Veronia



1 Chromovaná lesklá
Chromovaná lesklá
Chrom poľsk
Krómozott, fényes



2 Nerezový vzhľad kartáčovaný
Nerez finiš kartáčovaný
Imitacja stali nierdzewnej szczotkowanej
Nemesacél-hatású, Szálcsiszolt

Basilia



Nerezový vzhľad kartáčovaný
Nerez finiš kartáčovaný
Imitacja stali nierdzewnej szczotkowanej
Nemesacél-hatású, Szálcsiszolt

	•••	k ₁	k ₂		□
1	128	144	14	9 065 634	50
1	160	176	19	9 097 947	25
2	128	144	14	9 065 635	50
2	160	176	19	9 097 946	25

	□
	0 115 076 25

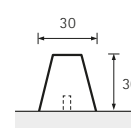
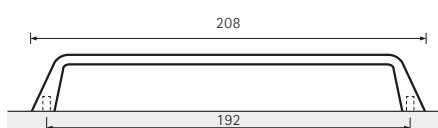
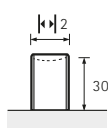
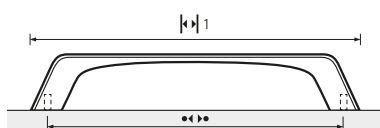

DELUXE

Arimini



- 1 Chromovaná lesklá / biela
 Chrómovaná lesklá / biela
 Chrom połysk / Biały
 Krómozott, fényes / fehér



- 2 Chromovaná lesklá / čierna
 Chrómovaná lesklá / čierna
 Chrom połysk / Czarny
 Krómozott, fényes / fekete

			☐
1	9 113 719	100	
2	9 112 664	100	

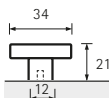

Opera



- Chromovaná lesklá
 Chrómovaná lesklá
 Chrom połysk
 Krómozott, fényes

☐	☐	☐	☐
96/128	135	9 113 675	50
160	200	9 113 678	25
192	232	9 113 681	25

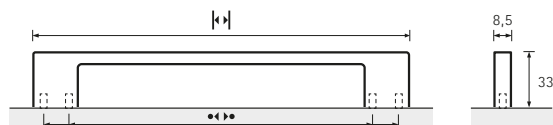

Saturnia



- Chromovaná lesklá
 Chrómovaná lesklá
 Chrom połysk
 Krómozott, fényes

		☐
9 113 712	50	

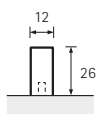
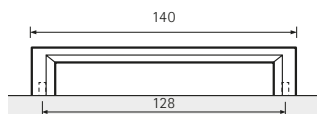

Delia



Chromovaná lesklá
 Chromovaná lesklá
 Chrom potysk
 Krómozott, fényes

••••	•••		📦
128	144	9 113 685	50
160	176	9 113 690	50

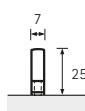
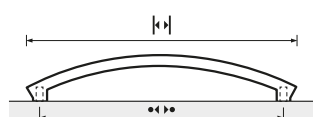

Lodi



1 Chromovaná lesklá
 Chromovaná lesklá
 Chrom potysk
 Krómozott, fényes



2 Zlatý vzhľad
 Zlatý vzhľad
 Imitácia zlota
 Aranyhatású

		📦
1	9 113 699	50
2	9 113 700	50

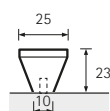

Sava



Chromovaná lesklá
 Chromovaná lesklá
 Chrom potysk
 Krómozott, fényes

		📦
	9 113 696	50

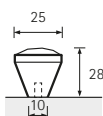

DELUXE

Solda



- 1 Chromovaná lesklá
Chrómovaná lesklá
Chrom polysk
Krómozott, fényes



- 2 Černá matná
Čierna matná
Czarny mat
Matt fekete

			☐
1	9 113 404	20	
2	9 269 741	20	

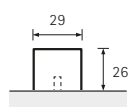
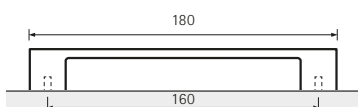

Londa



- 1 Chromovaná lesklá
Chrómovaná lesklá
Chrom polysk
Krómozott, fényes

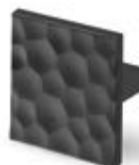

- 2 Černá matná
Čierna matná
Czarny mat
Matt fekete

			☐
1	9 113 397	20	
2	9 269 742	20	

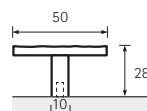
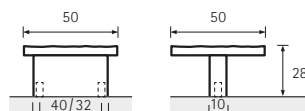

Fogo



Nerezový vzhled kartáčovaný
Nerez finiš kartáčovaný
Imitacja stali nierdzewnej szczotkowanej
Nemesacél-hatású, Szálcsiszolt

Bona



1 Chromovaná lesklá
Chrómovaná lesklá
Chrom połysk
Krómozott, fényes

2 Nerezový vzhled kartáčovaný
Nerez finiš kartáčovaný
Imitacja stali nierdzewnej szczotkowanej
Nemesacél-hatású, Szálcsiszolt

		
9 113 224	50	

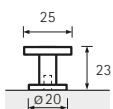

		
1	9 070 520	75
2	9 070 523	75

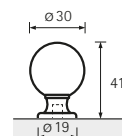

ORGANIC



56 Neapolis



56 Tolfo



56 Athena



57 Borgoa



57 Olivia



58 Aboa



58 Felina



59 Coria



59 Parma



60 Balmo



60 Carvo



61 Nicia



62 Bathia



62 Matilo



63 Salona



63 Ovada



64 Fectio



64 Vantania



65 Tolosa



65 Dinia



66 Naila



66 Culmen



67 Vada



68 Avenio



69 Asopus



69 Belna



70 Lucca



70 Catana



71 Chalcis



71 Vieste



72 Suasa



72 Carolina



73 Trento



73 Meana



74 Codania



75 Tardiano



75 Ladera



75 Issa



75 Sipontum



76 Sala



76 Almus



77 Cirpi



77 Serbinum

ORGANIC

Neapolis



- 1 Chromovaná lesklá
Chrómovaná lesklá
Chrom poľysk
Krómozott, fényes



- 2 Nerezový vzhľad kartáčovaný
Nerez finiš kartáčovaný
Imitácia stali nierdzewnej szczotkowanej
Nemesacél-hatású, Szálcsiszolt

		☐
1	0 115 122	25
2	9 114 747	25

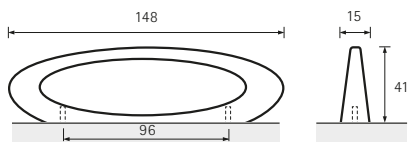

Tolfo



- 1 Chromovaná lesklá
Chrómovaná lesklá
Chrom poľysk
Krómozott, fényes



- 2 Nerezový vzhľad kartáčovaný
Nerez finiš kartáčovaný
Imitácia stali nierdzewnej szczotkowanej
Nemesacél-hatású, Szálcsiszolt

		☐
1	9 097 900	25
2	9 097 899	25

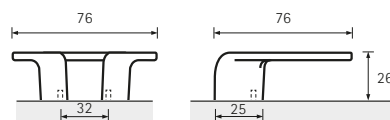

Athena



- 1 Chromovaná lesklá
Chrómovaná lesklá
Chrom poľysk
Krómozott, fényes



- 2 Aluminium finiš
Hliníkový vzhľad
Imitácia aluminium
Alumíniumhatású

		☐
1	9 065 425	20
2	9 065 427	20
3	9 065 426	20



- 3 Nerezový vzhľad kartáčovaný
Nerez finiš kartáčovaný
Imitácia stali nierdzewnej szczotkowanej
Nemesacél-hatású,

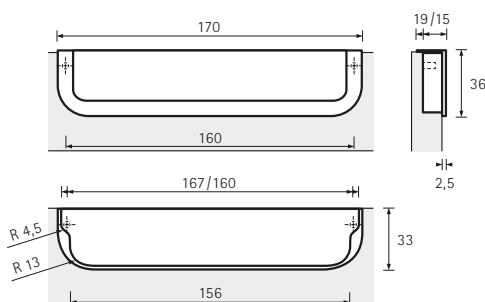

Borgoa



- 1 Chromovaná lesklá
Chrómovaná lesklá
Chrom poľysk
Krómozott, fényes



- 2 Chromovaná matná
Chrómovaná matná
Chrom mat
Krómozott, matt



- 3 Niklovaná matná
Niklovaná matná
Nikiel mat
Nikkelezett, matt



- 4 Nerezový vzhľad
Nerez finiš
Imitácia stali nierdzewnej
Nemesacél-hatású

1	9 070 574	75
2	9 070 567	75
3	9 070 565	75
4	9 070 556	75

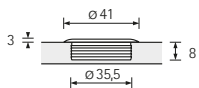

Olivia



- 1 Chromovaná lesklá
Chrómovaná lesklá
Chrom poľysk
Krómozott, fényes



- 2 Aluminium finiš
Hliníkový vzhľad
Imitácia aluminium
Aluminiumhatású



- 3 Černá matná
Čierna matná
Czarny mat
Fekete, matt

1	9 277 179	15
2	9 266 415	15
3	9 266 416	15

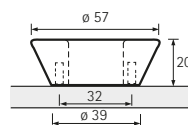

ORGANIC

Aboa



- 1 Nerezová ocel kartáčovaná
Nerezová ocel kartáčovaná
Stal nierdzewna szczotkowana
Nemesacél, Szálcsiszolt



- 2 Nerezová ocel kartáčovaná / černá lesklá
Stal nierdzewna szczotkowana /
Czarny połysk
Nemesacél, Szálcsiszolt /
feketén csillogó

		☐
1	9 070 138	25
2	9 207 534	25

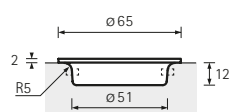

Felina



- 1 Chromovaná lesklá
Chrómovaná lesklá
Chrom połysk
Krómozott, fényes



- 2 Nerezový vzhled kartáčovaný
Nerez finiš kartáčovaný
Imitacja stali nierdzewnej szczotkowanej
Nemesacél-hatású, Szálcsiszolt



- 3 Černá matná
Čierna matná
Czarny mat
Fekete, matt

		☐
1	9 113 373	15
2	9 113 371	15
3	9 265 887	15

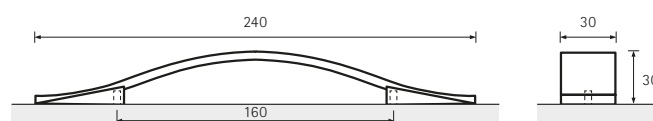

Coria



- 1 Chromovaná lesklá
Chromovaná lesklá
Chrom poľusk
Krómozott, fényses



- 2 Chromovaná matná
Chromovaná matná
Chrom mat
Krómozott, matt



- 3 Niklovaná matná
Niklovaná matná
Nikiel mat
Nikkelezett, matt



- 4 Nerezový vzhľad kartáčovaný
Nerez finiš kartáčovaný
Imitacja stali nierdzewnej szczotkowanej
Nemesacél-hatású, Szálcsiszolt

1	9 070 624	50	
2	9 112 597	50	
3	9 112 596	50	
4	9 112 595	50	

Parma



- 1 Chromovaná lesklá
Chromovaná lesklá
Chrom poľusk
Krómozott, fényses



- 2 Nerezový vzhľad kartáčovaný
Nerez finiš kartáčovaný
Imitacja stali nierdzewnej szczotkowanej
Nemesacél-hatású, Szálcsiszolt

1	9 113 468	50	
2	9 113 467	50	

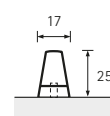
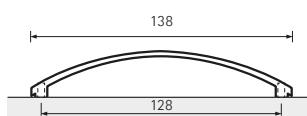
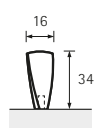
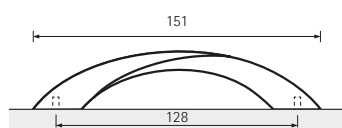

ORGANIC

Balmo



- 1 Chromovaná matná
Chrómovaná matná
Chrom mat
Krómozott, matt



- 2 Nerezový vzhled kartáčováný
Nerez finiš kartáčováný
Imitacja stali nierdzewnej szczotkowanej
Nemesacél-hatású, Szálcsiszolt

Carvo



- Nerezový vzhled kartáčováný
Nerez finiš kartáčováný
Imitacja stali nierdzewnej szczotkowanej
Nemesacél-hatású, Szálcsiszolt

		☐
1	0 074 134	25
2	0 043 472	25

		☐
	9 112 623	50

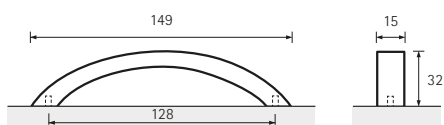

Nicia



- 1 Chromovaná lesklá
Chromovaná lesklá
Chrom polysk
Krómozott, fényes

	•••		≡		□
1	96	112	30	9 070 983	50
1	128	148	30	9 071 037	50
1	160	184	32	9 070 997	50
1	192	221	32	9 071 018	50
1	224	258	32	9 071 049	50



- 2 Chromovaná matná
Chromovaná matná
Chrom mat
Krómozott, matt

2	96	112	30	9 070 986	50
2	128	148	30	9 071 039	50
2	160	184	32	9 071 001	50
2	192	221	32	9 070 784	50
2	224	258	32	9 071 063	50



- 3 Niklovaná matná
Niklovaná matná
Nikiel mat
Nikkelezett, matt

3	96	112	30	9 071 014	50
3	128	148	30	9 070 976	50
3	160	184	32	9 071 016	50
3	192	221	32	9 071 019	50
3	224	258	32	9 070 980	50



- 4 Nerezový vzhled kartáčovaný
Nerez finiš kartáčovaný
Imitacja stali nierdzewnej szczotkowanej
Nemesacél-hatású, Szálcsiszolt

4	96	112	30	9 070 985	50
4	128	148	30	9 071 067	50
4	160	184	32	9 070 722	50
4	192	221	32	9 070 723	50
4	224	258	32	9 071 068	50



5	96	112	30	9 306 945	50
5	128	148	30	9 306 946	50
5	160	184	32	9 306 947	50
5	192	221	32	9 306 948	50
5	224	258	32	9 306 949	50

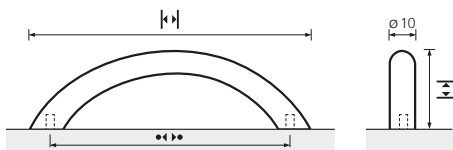

ORGANIC

Bathia



- 1 Chromovaná lesklá
Chromovaná lesklá
Chrom poľusk
Krómozott, fényes



- 2 Nerezový vzhľad kartáčovaný
Nerez finiš kartáčovaný
Imitácia stali nierdzewnej szczotkowanej
Nemesacél-hatású, Szálcsiszolt

Matilo



- 1 Chromovaná matná
Chromovaná matná
Chrom mat
Krómozott, matt



- 2 Niklovaná matná
Niklovaná matná
Nikel mat
Nikkelezett, matt



- 3 Nerezový vzhľad kartáčovaný
Nerez finiš kartáčovaný
Imitácia stali nierdzewnej szczotkowanej
Nemesacél-hatású, Szálcsiszolt

	•••	•		□
1	96	118	9 070 492	50
1	128	151	9 070 508	50
2	96	118	9 070 493	50
2	128	151	9 070 516	50

		□
1	9 112 914	50
2	0 115 195	50
3	9 206 642	50

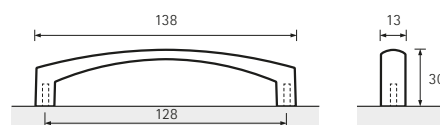
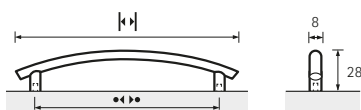

Salona



Nerezový vzhled kartáčovaný
Nerez finiš kartáčovaný
Imitácia stali nierdzewnej szczotkowanej
Nemesacél-hatású, Szálcsiszolt

Ovada



1 Chromovaná lesklá
Chrómovaná lesklá
Chrom poľysk
Krómozott, fényes



2 Nerezový vzhled kartáčovaný
Nerez finiš kartáčovaný
Imitácia stali nierdzewnej szczotkowanej
Nemesacél-hatású, Szálcsiszolt

				☐
1	170	155	30	

		☐	☐	☐	☐
1	96	139	9 118 524	50	
1	160 / 192	266	9 118 521	50	
1	256 / 320	362	9 118 518	25	
2	96	139	9 118 523	50	
2	160 / 192	266	9 118 520	50	
2	256 / 320	362	9 118 517	25	

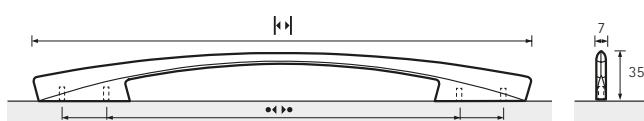
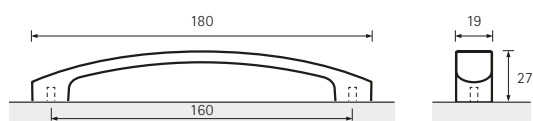

ORGANIC

Fectio



- 1 Chromovaná matná
Chrómovaná matná
Chrom mat
Krómozott, matt



- 2 Nerezový vzhled kartáčovaný
Nerez finiš kartáčovaný
Imitácia stali nierdzewnej szczotkowanej
Nemesacél-hatású, Szálcsiszolt

			☐
1	9 112 615	50	
2	9 112 613	50	

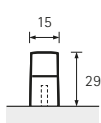
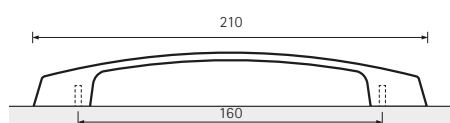

Vantania



- 1 Chromovaná lesklá
Chrómovaná lesklá
Chrom poľsk
Krómozott, fényes



- 2 Chromovaná matná
Chrómovaná matná
Chrom mat
Krómozott, matt



- 3 Nerezový vzhled kartáčovaný
Nerez finiš kartáčovaný
Imitácia stali nierdzewnej szczotkowanej
Nemesacél-hatású, Szálcsiszolt

			☐
1	9 113 211	25	
2	9 113 210	25	
3	1 170 158	25	

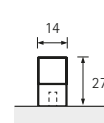
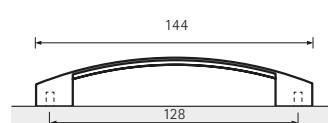

Tolosa



- 1 Chromovaná matná
Chrómovaná matná
Chrom mat
Krómozott, matt



- 2 Niklovaná matná
Niklovaná matná
Nikiel mat
Nikkelezett, matt

Dinia



- 1 Chromovaná matná
Chrómovaná matná
Chrom mat
Krómozott, matt



- 2 Nerezový vzhled kartáčovaný
Nerez finiš kartáčovaný
Imitacja stali nierdzewnej szczotkowanej
Nemesacél-hatású, Szálcsiszolt

	•••			□
1	96	126	9 112 910	30
1	128	157	9 112 909	25
2	96	126	0 115 203	30
2	128	157	9 113 514	25

	•••	₁	₂	□	□
1	96	118	16 28	9 070 754	75
1	128	143	18 29	9 070 752	50
2	96	118	16 28	9 070 675	75
2	128	143	18 29	9 070 681	50

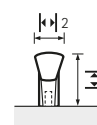
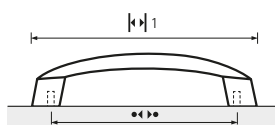
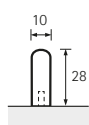
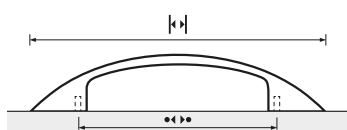

ORGANIC

Naila



1 Hliník eloxovaný
Hliník eloxovaný
Aluminium anodowane
Eloxált alumínium



2 Hnědá metalíza kartáčovaná
Hnědá metalíza kartáčovaná
Brązowy metaliczny szczotkowany
Barna fémes, Szálcsiszolt



3 Černá matná
Čierna matná
Czarny mat
Fekete, matt

	•••	•		□
1	64	71	9 190 399	50
1	96	103	9 190 421	50
1	128	135	9 190 422	50
1	160	167	9 190 423	50
1	192	199	9 190 424	50
1	256	263	9 190 425	50
1	288	295	9 190 426	50
1	320	327	9 190 427	50
2	64	71	9 190 428	50
2	96	103	9 190 429	50
2	128	135	9 190 430	50
2	160	167	9 190 431	50
2	192	199	9 190 432	50
2	256	263	9 190 433	50
2	288	295	9 190 434	50
2	320	327	9 190 435	50

	•••	•		□
3	64	71	9 266 077	50
3	96	103	9 266 078	50
3	128	135	9 266 079	50
3	160	167	9 266 080	50
3	192	199	9 266 091	50
3	256	263	9 266 092	50
3	288	295	9 266 093	50
3	320	327	9 266 094	50

Culmen



1 Hliník eloxovaný
Hliník eloxovaný
Aluminium anodowane
Eloxált alumínium



2 Nerezový vzhľad kartáčovaný
Nerez finiš kartáčovaný
Imitacja stali nierdzewnej szczotkowanej
Nemesacél-hatású, Szálcsiszolt

	•••	•		□
1	96	104	0 115 146	50
1	128	136	0 115 147	50
1	160	168	0 115 148	50
1	192	200	0 115 149	50
1	224	232	0 115 150	50
1	288	296	0 115 152	50
1	352	360	0 115 153	25
2	96	104	9 206 115	50
2	128	136	9 206 116	50
2	160	168	9 206 117	50
2	192	200	9 206 119	50
2	224	232	9 206 120	50
2	288	296	9 206 122	50
2	352	360	9 206 124	25

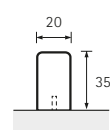
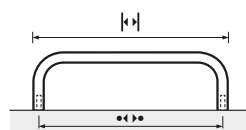
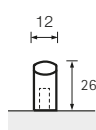
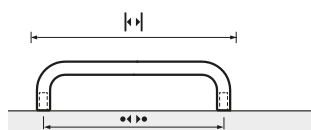

Vada



Nerezová oceľ kartáčovaná
 Nerezová oceľ kartáčovaná
 Stal nierdzewna szczotkowana
 Nemesacél, Szálcsiszolt

«»	«»	☒		☐
64	75	30	9 070 440	75
96	111	30	9 070 446	50
128	149	30	9 070 501	50
160	184	32	9 070 451	50
192	222	32	9 070 457	50
224	260	32	9 070 504	50
256	297	32	9 070 466	50
288	335	32	9 070 509	50
320	368	34	9 070 481	50
352	392	41	9 070 494	50

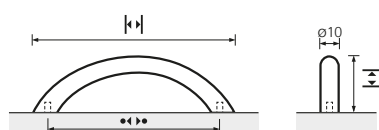

ORGANIC

Avenio



1 Chromovaná lesklá
Chromovaná lesklá
Chrom polysk
Krómozott, fényes



2 Chromovaná matná
Chromovaná matná
Chrom mat
Krómozott, matt



3 Niklovaná matná
Niklovaná matná
Nikiel mat
Nikkelezett, matt



4 Nerezový vzhľad kartáčovaný
Nerez finiš kartáčovaný
Imitacja stali nierdzewnej szczotkowanej
Nemesacél-hatású, Szálcsiszolt



5 Černá matná
Čierna matná
Czarny mat
Fekete, matt

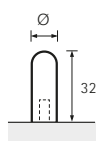
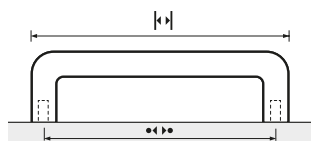

	Ø	•••			□
1	8	64	72	9 070 605	50
1	8	96	104	9 070 602	50
1	8	128	136	9 070 075	50
1	10	64	74	9 070 443	50
1	10	96	106	9 070 519	50
1	10	128	138	9 070 625	50
1	10	160	170	9 070 548	75
1	10	192	202	9 069 899	50
1	10	288	298	9 069 922	50
1	10	352	362	9 069 900	25
2	8	64	72	9 069 943	50
2	8	96	104	9 070 054	50
2	8	128	136	9 070 078	50
2	10	64	74	9 070 444	50
2	10	96	106	9 070 521	50
2	10	128	138	9 070 540	50
2	10	160	170	9 070 552	75
2	10	192	202	9 070 572	50
2	10	288	298	9 069 877	50
2	10	352	362	9 069 892	25
3	8	64	72	9 069 919	50
3	8	96	104	9 069 915	50
3	8	128	136	9 069 907	50
3	10	64	74	9 070 511	50
3	10	96	106	9 070 522	50
3	10	128	138	9 070 619	50
3	10	160	170	9 069 909	75
3	10	192	202	9 069 868	50
3	10	288	298	9 069 867	50
3	10	352	362	9 069 873	25
4	8	64	72	9 070 030	50
4	8	96	104	9 070 439	50
4	8	128	136	9 070 429	50
4	10	64	74	9 070 512	50
4	10	96	106	9 070 527	50
4	10	128	138	9 070 448	50
4	10	160	170	9 070 557	75
4	10	192	202	9 070 577	50
4	10	288	298	9 069 927	50
4	10	352	362	9 070 025	25
5	8	64	72	9 306 926	50
5	8	96	104	9 306 927	50
5	8	128	136	9 306 928	50
5	10	64	74	9 306 929	50
5	10	96	106	9 306 930	50
5	10	128	138	9 306 941	50
5	10	160	170	9 306 942	75
5	10	192	202	9 306 943	50
5	10	288	298	9 306 944	50
5	10	352	362	9 303 610	25

Asopus



Nerezová ocel kartáčovaná
Nerezová ocel kartáčovaná
Stal nierdzewna szczotkowana
Nemesacél, Szálcsiszolt

Belna



Nerezový vzhled kartáčovaný
Nerez finiš kartáčovaný
Imitacja stali nierdzewnej szczotkowanej
Nemesacél-hatású, Szálcsiszolt

Ø	•••		≡		□
8	64	72	32	9 070 096	50
8	96	104	32	9 069 942	50
8	128	136	32	9 070 101	50
10	96	106	32	9 069 815	50
10	128	138	32	9 069 818	50
10	160	170	32	9 070 124	75
10	192	202	32	9 070 420	50
10	224	234	32	9 069 821	50
10	320	330	32	9 069 865	50
10	352	362	32	9 070 421	25
12	96	108	40	9 070 102	50
12	128	140	40	9 070 103	50
12	160	172	40	9 070 117	50
12	192	204	40	9 070 105	50
12	224	236	40	9 070 118	50
12	320	332	40	9 070 119	50
12	352	364	40	9 070 111	25
12	480	492	40	9 070 120	25
12	704	716	40	9 070 122	25

•••			□
128	135	0 115 169	50
160	167	0 115 170	50

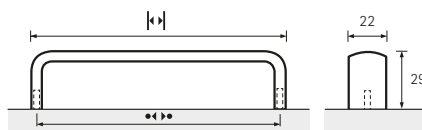
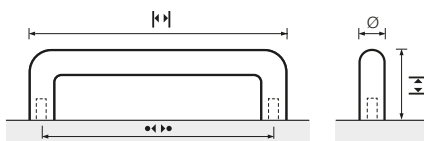

ORGANIC

Lucca



- 1 Chromovaná lesklá
Chrómovaná lesklá
Chrom poľysk
Krómozott, fényes



- 2 Nerezový vzhľad kartáčovaný
Nerez finiš kartáčovaný
Imitácia stali nierdzewnej szcztokwanej
Nemesacél-hatású, Szálcsiszolt

		☐
1	9 113 510	25
2	9 113 511	25

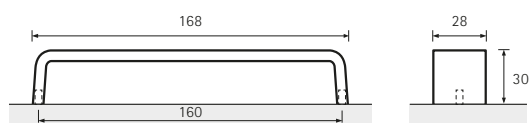

Catana



- 1 Hliník eloxovaný
Hliník eloxovaný
Aluminium anodowane
Eloxált aluminium



- 2 Nerezový vzhľad kartáčovaný
Nerez finiš kartáčovaný
Imitácia stali nierdzewnej szcztokwanej
Nemesacél-hatású, Szálcsiszolt

	•••	•	☐
1	192	199	9 113 733 25
1	320	327	9 113 734 25
2	192	199	0 115 080 25
2	320	327	0 115 081 25

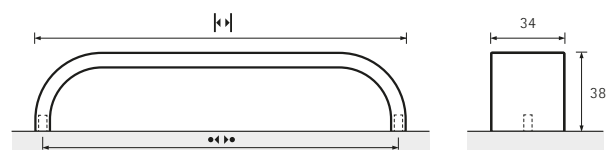

Chalcis



Nerezový vzhled kartáčovaný
Nerez finiš kartáčovaný
Imitacja stali nierdzewnej szczotkowanej
Nemesacél-hatású, Szálcsiszolt

Vieste



Nerezový vzhled kartáčovaný
Nerez finiš kartáčovaný
Imitacja stali nierdzewnej szczotkowanej
Nemesacél-hatású, Szálcsiszolt

•••	•		□
128	147	9 113 183	40
288	301	9 113 182	40

•••	•		□
96	120	9 995 497	20
128	152	9 995 498	15
160	184	9 995 499	25
192	216	9 995 500	20
224	248	9 995 501	20

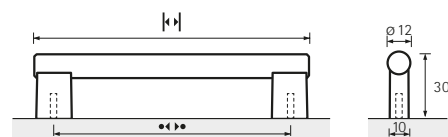
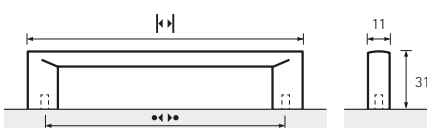

ORGANIC

Suasa



- 1 Chromovaná lesklá
Chrómovaná lesklá
Chrom poľsk
Krómozott, fényes



- 2 Nerezový vzhľad kartáčovaný
Nerez finiš kartáčovaný
Imitacja stali nierdzewnej szczotkowanej
Nemesacél-hatású, Szálcsiszolt

1	9 112 916	25	
2	9 112 915	25	

Carolina



- 1 Chromovaná lesklá
Chrómovaná lesklá
Chrom poľsk
Krómozott, fényes



- 2 Nerezový vzhľad kartáčovaný
Nerez finiš kartáčovaný
Imitacja stali nierdzewnej szczotkowanej
Nemesacél-hatású, Szálcsiszolt

1	9 080 858	50	
2	9 080 859	50	

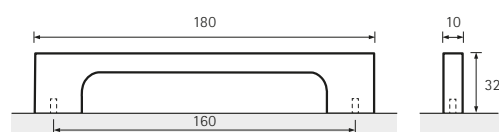
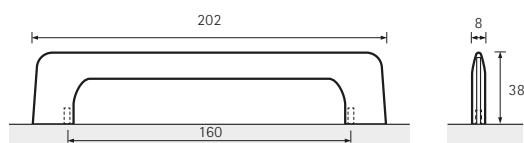

Trento



- 1 Chromovaná lesklá
Chrómovaná lesklá
Chrom poľusk
Krómózott, fényes



- 2 Nerezový vzhľad kartáčovaný
Nerez finiš kartáčovaný
Imitácia stali nierzewnej szczotkowanej
Nemesacél-hatású, Szálcsiszolt

Meana



- Nerezový vzhľad kartáčovaný
Nerez finiš kartáčovaný
Imitacja stali nierzewnej szczotkowanej
Nemesacél-hatású, Szálcsiszolt

	•••	•		□
1	32	93	9 070 095	100
1	96	171	9 070 123	50
2	32	93	9 070 121	100
2	96	171	9 070 125	50

	□
	9 114 539 25

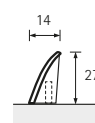
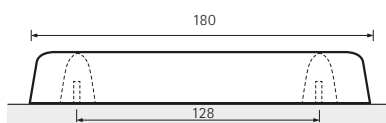
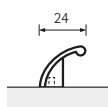
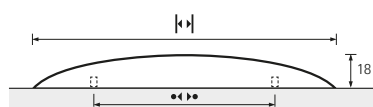

ORGANIC

Codania



- 1 Nerezový vzhľad kartáčovaný
Nerez finiš kartáčovaný
Imitacja stali nierdzewnej szczotkowanej
Nemesacél-hatású, Szálcsiszolt



- 2 Černá matná
Čierna matná
Czarny mat
Fekete, matt



- 3 Zlatý vzhľad, matne kartáčovaný
Zlatý vzhľad matný kartáčovaný
Imitacja złota szczotkowanego mat
Ranyhatású, matt, kefélt

	k1	k2			k1	k2			k1	k2				
1	295	236	9 209 994	50	2	295	236	9 265 997	50	3	295	236	9 266 067	50
1	345	275	9 209 995	25	2	345	275	9 265 998	25	3	345	275	9 266 068	25
1	395	315	9 209 996	25	2	395	315	9 265 999	25	3	395	315	9 266 069	25
1	445	355	9 209 997	25	2	445	355	9 266 000	25	3	445	355	9 266 070	25
1	495	395	9 210 058	25	2	495	395	9 266 001	25	3	495	395	9 266 071	25
1	595	475	9 210 059	25	2	595	475	9 266 002	25	3	595	475	9 266 072	25
1	795	635	9 210 060	25	2	795	635	9 266 003	25	3	795	635	9 266 073	25
1	895	715	9 210 061	25	2	895	715	9 266 004	25	3	895	715	9 266 074	25
1	995	795	9 210 062	25	2	995	795	9 266 005	25	3	995	795	9 266 075	25
1	1195	954	9 210 063	20	2	1195	954	9 266 006	20	3	1195	954	9 266 076	20

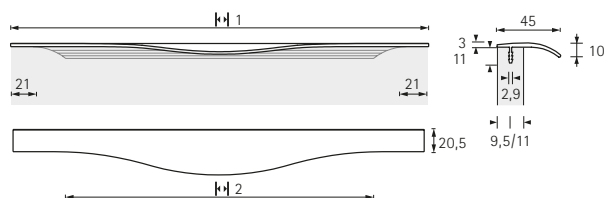

Tardiano



- 1 Nerezový vzhled kartáčovaný
Nerez finiš kartáčovaný
Imitacja stali nierdzewnej szczotkowanej
Nemesacél-hatású, Szálcsiszolt



- 2 Černá matná
Čierna matná
Czarny mat
Fekete, matt

1	9 266 141	25
2	9 266 142	25

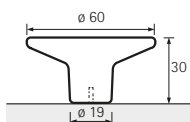

Ladera



- Niklovaná matná
Niklovaná matná
Nikel mat
Nikkelezett, matt

9 112 644	50
-----------	----

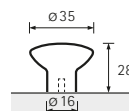

Issa



- 1 Chromovaná lesklá
Chrómovaná lesklá
Chrom połysk
Krómozott, fényes



- 2 Nerezový vzhled kartáčovaný
Nerez finiš kartáčovaný
Imitacja stali nierdzewnej szczotkowanej
Nemesacél-hatású, Szálcsiszolt



- 3 Černá matná
Čierna matná
Czarny mat
Fekete, matt

1	9 203 958	50
2	0 115 312	50
3	9 265 885	50

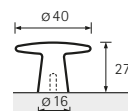

Sipontum



- Nerezová ocel kartáčovaná
Nerezová ocel kartáčovaná
Stal nierdzewna szczotkowana
Nemesacél, Szálcsiszolt

9 070 568	75
-----------	----

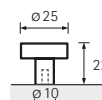

ORGANIC

Sala



- 1 Chromovaná lesklá
Chrómovaná lesklá
Chrom poľsk
Krómozott, fényes



- 2 Mosazný vzhľad lesklý
Mosadzný vzhľad lesklý
Imitácia mosiádu poľsk
Sárgarézhatású, fényes

1	9 071 110	75
2	9 071 109	75

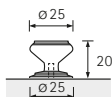

Almus



- 1 Chromovaná lesklá
Chrómovaná lesklá
Chrom poľsk
Krómozott, fényes



- 2 Chromovaná matná
Chrómovaná matná
Chrom mat
Krómozott, matt



- 3 Niklovaná matná
Niklovaná matná
Nikiel mat
Nikkelezett, matt



- 4 Nerezový vzhľad kartáčovaný
Nerez finiš kartáčovaný
Imitácia stali nierdzewnej szczotkowanej
Nemesacél-hatású, Szálcsiszolt



- 5 Měděný vzhľad lesklý
Medený vzhľad lesklý
Imitácia miedzi poľsk
Sárgarézhatású, fényes

1	9 112 583	50
2	9 112 590	50
3	9 112 588	50
4	9 114 036	50
5	9 204 136	50

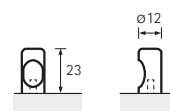

Cirpi



1 Bílá
Biela
Biały
Fehér



2 Chromovaná lesklá
Chrómovaná lesklá
Chrom polysk
Krómozott, fényes



3 Chromovaná matná
Chrómovaná matná
Chrom mat
Krómozott, matt



4 Niklovaná matná
Niklovaná matná
Nikiel mat
Nikkelezett, matt



5 Nerezový vzhled kartáčovaný
Nerez finiš kartáčovaný
Imitacja stali nierdzewnej szczotkowanej
Nemesacél-hatású, Szálcsiszolt

Serbinum



Nerezová oceľ kartáčovaná
Nerezová oceľ kartáčovaná
Stal nierdzewna szczotkowana
Nemesacél, Szálcsiszolt

			☐
1	9 070 589	30	
2	9 070 585	30	
3	9 070 581	30	
4	9 070 586	30	
5	9 206 738	30	

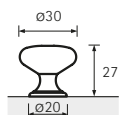

			☐
	9 070 562	75	

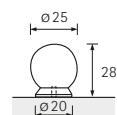

FOLK



80 Cato



83 Luro



85 Topeka



88 Valentia



91 Ogulin



80 Calili



83 Tarraco



86 Siradia



89 Egara



92 Meduno



81 Ponzone



83 Pomezia



86 Sertao



89 Bruxella



92 Flavia



81 Ponti



83 Potovio



87 Haida



90 Salacia



92 Emo



82 Corduba



84 Barcino



87 Terranda



90 Eburaco



93 Bevipo



82 Vesontio



84 Bracara



87 Gissi



90 Savelli



93 Dipo



82 Ponoka



84 Olisipo



87 Osimo



90 Salemi



94 Byzantia



82 Oka



85 Arezzo



88 Malaca



91 Alberta



94 Getafe



95 Gela



98 Lorica



101 Altedo



95 Galati



98 Matane



101 Larru



96 Nica



98 Dodona



96 Filaga



99 Essa



97 Agna



99 Tonala



97 Agliano



100 Galleno



97 Dublina



100 Fossa



97 Arago



100 Solva

FOLK

Cato



Cínový vzhľad antik
Cínový vzhľad antik
Imitácia antycznej cyny
Ónhatású, antik

9 208 030 30

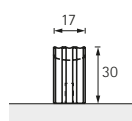

Calili



Cínový vzhľad antik
Cínový vzhľad antik
Imitácia antycznej cyny
Ónhatású, antik

9 208 068 100

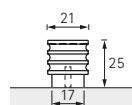

Ponzone



- 1 Cínový vzhľad antik
Cínový vzhľad antik
Imitácia antycznej cyny
Ónhatású, antik



- 2 Bronzový vzhľad antik
Bronzový vzhľad antik
Imitácia antycznego brązu
Bronzhatású, antik

Ponti



- 1 Cínový vzhľad antik
Cínový vzhľad antik
Imitácia antycznej cyny
Ónhatású, antik



- 2 Bronzový vzhľad antik
Bronzový vzhľad antik
Imitácia antycznego brązu
Bronzhatású, antik

1	9 206 136	50		
2	9 113 430	50		

1	9 206 134	200		
2	9 113 429	200		

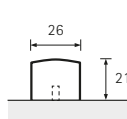
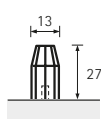
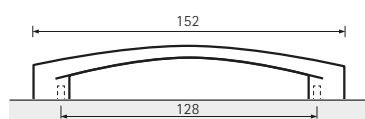

FOLK

Corduba



Cínový vzhľad
Cínový vzhľad
Imitácia cyny
Ónhatású

		☐
0 115 266	50	

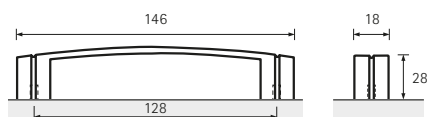

Vesontio



Cínový vzhľad
Cínový vzhľad
Imitácia cyny
Ónhatású

		☐
9 112 635	25	



Ponoka



1 Chromovaná lesklá
Chrómovaná lesklá
Chrom poľsk
Krómózott, fényes



2 Cínový vzhľad
Cínový vzhľad
Imitácia cyny
Ónhatású

		☐
1	9 080 851	50
2	9 080 850	50

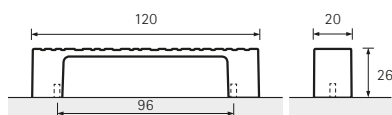

Oka



1 Chromovaná lesklá
Chrómovaná lesklá
Chrom poľsk
Krómózott, fényes



2 Cínový vzhľad
Cínový vzhľad
Imitácia cyny
Ónhatású

		☐
1	9 080 852	100
2	9 080 853	100

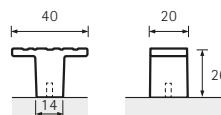

Luro



1 Cínový vzhľad
Cínový vzhľad
Imitácia cyny
Ónhatású



2 Mosazný vzhľad antik
Mosazný vzhľad antik
Imitácia antycznego mosiądzu
Sárgarézhatású, antik



3 Černá matná vintage
Čierna matná vintage
Czarny mat vintage
Fekete, matt, Vintage

			☐
1	9 112 601	50	
2	9 206 237	50	
3	9 206 239	50	

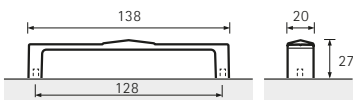

Tarraco



1 Cínový vzhľad
Cínový vzhľad
Imitácia cyny
Ónhatású



2 Mosazný vzhľad antik
Mosazný vzhľad antik
Imitácia antycznego mosiądzu
Sárgarézhatású, antik



3 Černá matná vintage
Čierna matná vintage
Czarny mat vintage
Fekete, matt, Vintage

			☐
1	9 112 607	40	
2	9 206 137	40	
3	9 206 138	40	

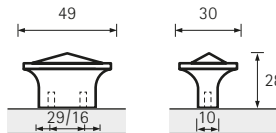

Pomezia



Mosazný vzhľad antik
Mosazný vzhľad antik
Imitácia antycznego mosiądzu
Sárgarézhatású, antik

☐	☐	☐	☐
96	104	9 266 566	25
128	136	9 266 567	20
160	168	9 266 568	25

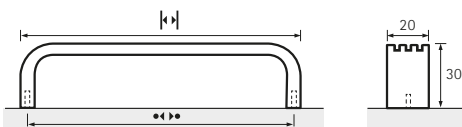

Potovio



Cínový vzhľad
Cínový vzhľad
Imitácia cyny
Ónhatású

		☐
9 112 650	50	

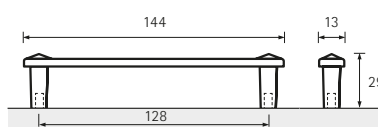

FOLK

Barcino



- 1 Cínový vzhľad
Cínový vzhľad
Imitácia cyny
Ónhatású



- 2 Mosazný vzhľad antik
Mosadzný vzhľad antik
Imitacja antycznego mosiądzu
Sárgarézhatású, antik



- 3 Černá matná vintage
Čierna matná vintage
Czarny mat vintage
Fekete, matt, Vintage

	□
1	9 112 652 100
2	9 206 130 100
3	9 206 131 100

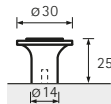

Bracara



- 1 Cínový vzhľad
Cínový vzhľad
Imitácia cyny
Ónhatású



- 2 Mosazný vzhľad antik
Mosadzný vzhľad antik
Imitacja antycznego mosiądzu
Sárgarézhatású, antik



- 3 Černá matná vintage
Čierna matná vintage
Czarny mat vintage
Fekete, matt, Vintage

	□	□	□	□	□	□
1	96	114	32	9	112	631 50
1	128	150	33	9	112	600 50
2	96	114	32	9	206	126 50
2	128	150	33	9	206	127 50
3	96	114	32	9	206	128 50
3	128	150	33	9	206	129 50

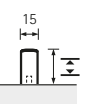
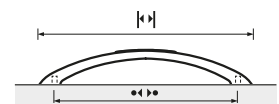

Olisipo



- 1 Cínový vzhľad
Cínový vzhľad
Imitácia cyny
Ónhatású



- 2 Cínový vzhľad
Cínový vzhľad
Imitácia cyny
Ónhatású

	□
1	0 115 374 25
2	9 112 632 50

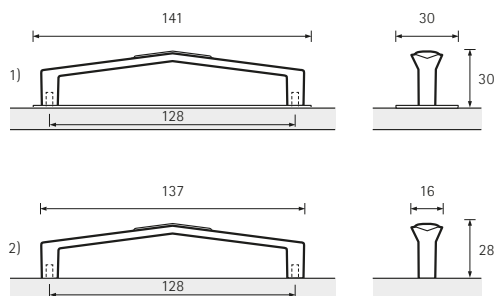

Arezzo



Cínový vzhľad
Cínový vzhľad
Imitácia cyny
Ónhatású

Topeka



Černá matná
Čierna matná
Czarny mat
Matt fekete

			☐
9 264 060	25		

•••	☐		☐
96	160	9 266 419	25
128	192	9 266 420	25
160	224	9 270 230	25

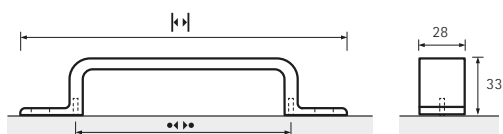
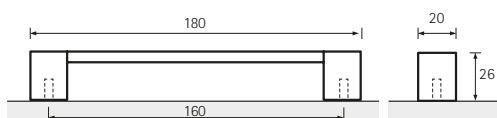

FOLK

Siradia



1 Cínový vzhľad antik
Cínový vzhľad antik
Imitácia antycznej cyny
Ōnhatású, antik



2 Mosazný vzhľad antik
Mosadzný vzhľad antik
Imitacja antycznego mosiądzu
Sárgarézhatású, antik

Sertao



1 Cínový vzhľad antik
Cínový vzhľad antik
Imitácia antycznej cyny
Ōnhatású, antik



2 Mosazný vzhľad antik
Mosadzný vzhľad antik
Imitacja antycznego mosiądzu
Sárgarézhatású, antik

			☐
1	9 208 026	25	
2	9 208 027	25	

			☐
1	9 208 064	40	
2	9 208 065	40	

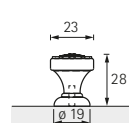
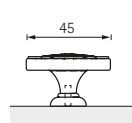
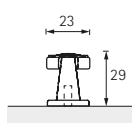
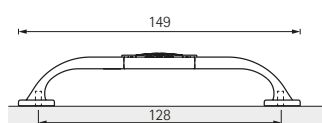

Haida



- 1 Nerezový vzhled kartáčovaný
Nerez finiš kartáčovaný
Imitácia stali nierdzewnej szczotkowanej
Nemesacél-hatású, Szálcsiszolt



- 2 Mosazný vzhled antik kartáčovaný
Mosadzný vzhľad antik kartáčovaný
Imitacja antycznego mosiądzu
szczonekowanego
Sárgarézhatású, antik,
Szálcsiszolt

1	9 113 225	50
2	9 113 227	50

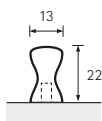
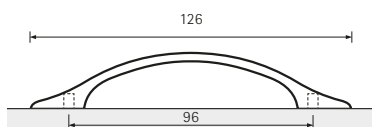

Terranda



- Nerezový vzhled kartáčovaný
Nerez finiš kartáčovaný
Imitacja stali nierdzewnej szczotkowanej
Nemesacél-hatású, Szálcsiszolt

•••	•	≡		□
96	112	24	9 113 327	50
128	146	28	9 113 292	40

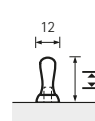
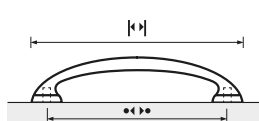

Gissi



- Cínový vzhled
Cínový vzhľad
Imitacja cyny
Ónhatású

	□
9 112 651	100

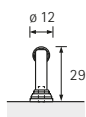
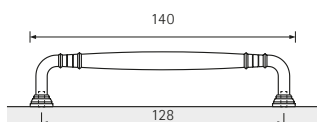

Osimo



- 1 Cínový vzhled antik
Cínový vzhľad antik
Imitacja antycznej cyny
Ónhatású, antik



- 2 Mosazný vzhled antik
Mosadzný vzhľad antik
Imitacja antycznego mosiądzu
Sárgarézhatású, antik

	□	
1	9 113 445	50
2	9 113 444	50

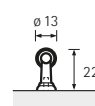
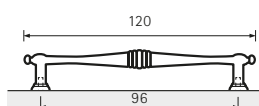

FOLK

Malaca



- 1 Cínový vzhľad
Cínový vzhľad
Imitácia cyny
Ónhatású



- 2 Mosazný vzhľad antik
Mosadzný vzhľad antik
Imitácia antycznego mosiądzu
Sárgarézhatású, antik

		☐
1	9 070 943	50
2	9 070 945	50

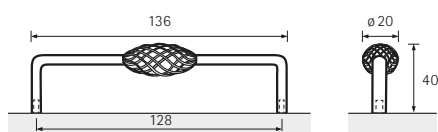

Valentia



- 1 Cínový vzhľad
Cínový vzhľad
Imitácia cyny
Ónhatású



- 2 Mosazný vzhľad antik
Mosadzný vzhľad antik
Imitácia antycznego mosiądzu
Sárgarézhatású, antik

		☐
1	9 070 510	75
2	9 070 513	75

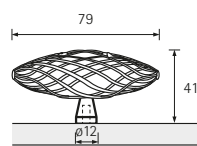

Egara



- 1 Cínový vzhľad kartáčovaný
Cínový vzhľad kartáčovaný
Imitácia cyny szcztokwanej
Ónhatású, Szálcsiszolt



- 2 Mosazný vzhľad antik kartáčovaný
Mosadzný vzhľad antik kartáčovaný
Imitacja antycznego mosiądzu
szcztokwanego
Sárgarézhatású, antik,
Szálcsiszolt



- 3 Bronzový vzhľad antik kartáčovaná
Bronzový vzhľad antik kartáčovaný
Imitacja antycznego brązu
Szcztokwanego
bronzhatású, antik, kefével féyesített

1	9 071 720	20	☐
2	9 071 719	20	
3	9 071 718	20	

Bruxella



- Nerezový vzhľad kartáčovaný
Nerez finiš kartáčovaný
Imitacja stali nierdzewnej szcztokwanej
Nemesacél-hatású, Szálcsiszolt

	9 112 619	50	☐

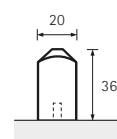
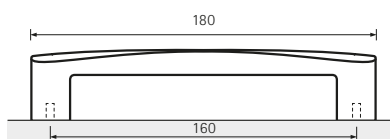
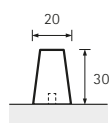
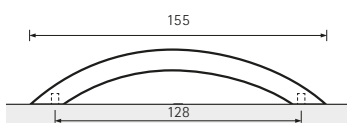

FOLK

Salacia



1 Stříbrný vzhled antik
Striborný vzhľad antik
Imitacja antycznego srebra
Ezüsthatású, antik



2 Cínový vzhled
Cínový vzhľad
Imitacja cyny
Ónhatású

	•••	K ₁	K ₂		□
1	128	151	23	9 112 594	50
2	128	151	23	9 112 591	50

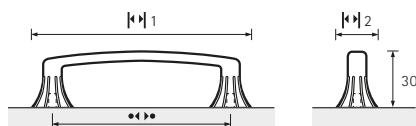

Eburaco



1 Stříbrný vzhled antik
Striborný vzhľad antik
Imitacja antycznego srebra
Ezüsthatású, antik



2 Cínový vzhled
Cínový vzhľad
Imitacja cyny
Ónhatású

		□
1	9 112 654	100
2	9 112 653	100

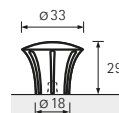

Savelli



Nerezový vzhled kartáčovaný
Nerez finiš kartáčovaný
Imitacja stali nierdzewnej szczotkowanej
Nemesacél-hatású, Szálcsiszolt

	□
9 113 483	50

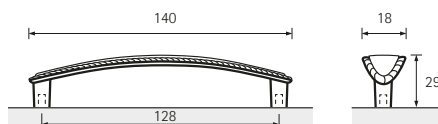

Salemi



Nerezový vzhled kartáčovaný
Nerez finiš kartáčovaný
Imitacja stali nierdzewnej szczotkowanej
Nemesacél-hatású, Szálcsiszolt

	□
9 113 368	75

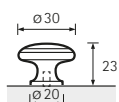

Alberta



- 1 Nerezový vzhľad kartáčovaný
Nerez finiš kartáčovaný
Imitácia stali nierdzewnej szczotkowanej
Nemesacél-hatású, Szálcsiszolt



- 2 Mosazný vzhľad antik
Mosadzný vzhľad antik
Imitacja antycznego mosiądzu
Sárgarézhatású, antik



- 3 Cínový vzhľad antik
Cínový vzhľad antik
Imitacja antycznej cyny
Ónhatású, antik

Ogulin



- Cínový vzhľad antik
Cínový vzhľad antik
Imitacja antycznej cyny
Ónhatású, antik

	□
1	9 113 181 50
2	9 113 179 50
3	9 113 180 50

•••		□
128	152	9 266 562 30
160	184	9 266 563 20
192	216	9 266 564 20
224	248	9 266 565 20

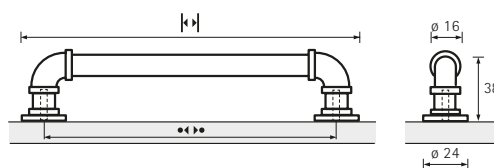
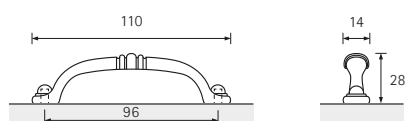

FOLK

Meduno



Cínový vzhľad
Cínový vzhľad
Imitácia cyny
Ónhatású

			□
9	112	662	50

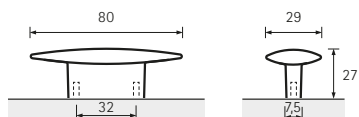

Emo



Nerezový vzhľad kartáčovaný
Nerez finiš kartáčovaný
Imitacja stali nierdzewnej szczotkowanej
Nemesacél-hatású, Szálcsiszolt

			□
1	170	173	40

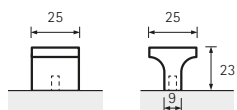

Flavia



1 Niklovaná matná
Niklovaná matná
Nikel mat
Nikkelezett, matt



2 Cínový vzhľad
Cínový vzhľad
Imitácia cyny
Ónhatású

			□
1	0	115	293
2	0	115	292
			50

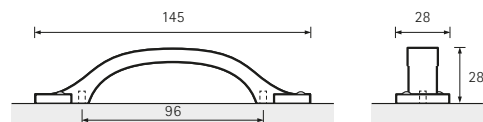

Bevipó



Cínový vzhľad
Cínový vzhľad
Imitácia cyny
Ónhatású

Dipo



Cínový vzhľad
Cínový vzhľad
Imitácia cyny
Ónhatású

0 115 263 50

0 115 264 100

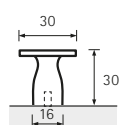
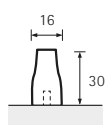
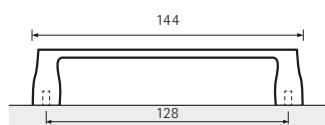

FOLK

Byzantia



- 1 Prává kůže tmavohnědá / nerezový vzhled kartáčovaný
Prává koža tmavá hnedá / nerez finiš kartáčovaný
Skóra naturalna, ciemnobrązowa / Imitacja stali nierdzewnej szczotkowanej
Sötétbarna, valódi bőr / nemesacél-hatású, Szálcsiszolt



- 2 Prává kůže tmavohnědá se vzorkem / nerezový vzhled kartáčovaný
Prává koža tmavá hnedá vzorovaná / nerez finiš kartáčovaný
Skóra naturalna, ciemnobrązowa ze wzorem / Imitacja stali nierdzewnej szczotkowanej
Sötétbarna, mintázott, valódi bőr / nemesacél-hatású, Szálcsiszolt



- 3 Prává kůže černá / nerezový vzhled kartáčovaný
Prává koža čierna / nerez finiš kartáčovaný
Skóra naturalna, czarna / Imitacja stali nierdzewnej szczotkowanej
Fekete, valódi bőr / nemesacél-hatású, Szálcsiszolt

Getafe



- 1 Prává kůže světlehnědá / nerezová ocel kartáčovaná
Prává koža svetlá hnedá / nerezová oceľ kartáčovaná
Skóra naturalna, jasnobrązowa / Stal nierdzewna szczotkowana
Világosbarna, valódi bőr / nemesacél, Szálcsiszolt



- 2 Prává kůže tmavohnědá / nerezová ocel kartáčovaná
Prává koža tmavá hnedá / nerezová oceľ kartáčovaná
Skóra naturalna, ciemnobrązowa / Stal nierdzewna szczotkowana
Sötétbarna, valódi bőr / nemesacél, Szálcsiszolt



- 3 Prává kůže černá / nerezová ocel kartáčovaná
Prává koža čierna / nerezová oceľ kartáčovaná
Skóra naturalna, czarna / Stal nierdzewna szczotkowana
Fekete, valódi bőr / nemesacél, Szálcsiszolt

	•••	•		□
1	128	188	9 070 143	40
1	160	220	9 070 148	40
2	128	188	9 070 144	40
2	160	220	9 070 149	40
3	128	188	9 070 142	40
3	160	220	9 070 147	40

	•••	•		□
1	160	170	9 131 321	50
1	224	234	9 131 324	50
2	160	170	9 131 320	50
2	224	234	9 131 323	50
3	160	170	9 131 319	50
3	224	234	9 131 322	50

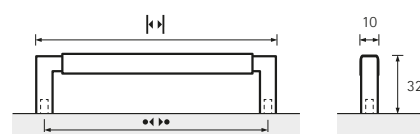
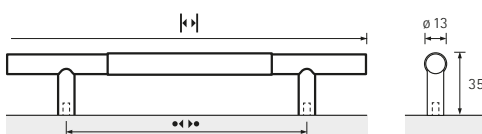

Gela



- 1 Prává kůže světlehnědá
Prává koža svetlá hnedá
Skóra naturalna, jasnobrązowa
Világosbarna, valódi bõr



- 2 Prává kůže tmavohnědá
Prává koža tmavá hnedá
Skóra naturalna, ciemnobrązowa
Sötétbarna, valódi bõr



- 3 Prává kůže černá
Prává koža čierna
Skóra naturalna, czarna
Fekete, valódi bõr

Přichytky viz str. 112
Prichytky vid' str. 112
Cokół montażowy patrz strona 112
Rögzítõtalpat lásd: 112. oldal

Galati



- 1 Prává kůže světlehnědá
Prává koža svetlá hnedá
Skóra naturalna, jasnobrązowa
Világosbarna, valódi bõr



- 2 Prává kůže tmavohnědá
Prává koža tmavá hnedá
Skóra naturalna, ciemnobrązowa
Sötétbarna, valódi bõr



- 3 Prává kůže černá
Prává koža čierna
Skóra naturalna, czarna
Fekete, valódi bõr

Přichytky viz str. 112
Prichytky vid' str. 112
Cokół montażowy patrz strona 112
Rögzítõtalpat lásd: 112. oldal

1	9 113 645	100	□
2	9 113 646	100	
3	9 113 647	100	

1	9 113 648	200	□
2	9 113 649	200	
3	9 113 650	200	

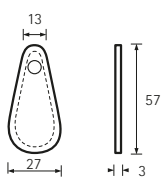
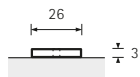
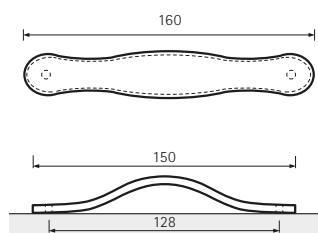

FOLK

Nica



- 1 Pravá kůže světlehnědá
Pravá koža svetlá hnedá
Skóra naturalna, jasnobrązowa
Világosbarna, valódi bőr



- 2 Pravá kůže tmavohnědá
Pravá koža tmavá hnedá
Skóra naturalna, ciemnobrązowa
Sötétbarna, valódi bőr



- 3 Pravá kůže černá
Pravá koža čierna
Skóra naturalna, czarna
Fekete, valódi bőr

Šrouby viz s tr. 112
Montážne skrutky vid' str. 112
Wkręt mocujący patrz strona 112
Rögzítő csavarokat lásd: 112. oldal

	•••	• ₁	• ₂	□
1	64	94	126	9 071 842 100
1	96	126	158	9 071 839 100
1	128	158	190	9 071 836 100
2	64	94	126	9 071 843 100
2	96	123	158	9 071 840 100
2	128	158	190	9 071 837 100
3	64	94	126	9 071 844 100
3	96	126	158	9 071 841 100
3	128	158	190	9 071 838 100

Filaga



- 1 Pravá kůže světlehnědá / niklovaná matná
Pravá koža svetlá hnedá / niklovaná matná
Skóra naturalna, jasnobrązowa / Nikiel mat
Világosbarna, valódi bőr / nikkelezett, matt



- 2 Pravá kůže tmavohnědá / niklovaná matná
Pravá koža tmavá hnedá / niklovaná matná
Skóra naturalna, ciemnobrązowa / Nikiel mat
Sötétbarna, valódi bőr / nikkelezett, matt



- 3 Pravá kůže černá / niklovaná matná
Pravá koža čierna / niklovaná matná
Skóra naturalna, czarna / Nikiel mat
Fekete, valódi bőr / nikkelezett, matt

	□
1	9 113 691 175
2	9 113 594 175
3	9 113 694 175

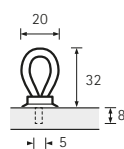
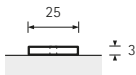
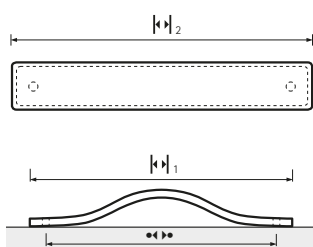

FOLK

Lorica



Cínový vzhľad
Cínový vzhľad
Imitácia cyny
Ónhatású

		☐
9 112 655	50	

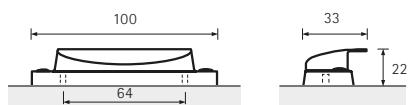

Matane



1 Nerezový vzhľad kartáčovaný
Nerez finiš kartáčovaný
Imitácia stali nierdzewnej szczotkowanej
Nemesacél-hatású, Szálcsiszolt



2 Černá matná
Čierna matná
Czarny mat
Fekete, matt

		☐
1	9 113 228	50
2	9 260 744	50

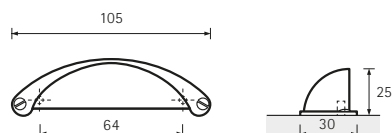

Dodona



Nerezová ocel kartáčovaná
Nerezová ocel kartáčovaná
Stal nierdzewna szczotkowana
Nemesacél, Szálcsiszolt

		☐
9 070 693	50	

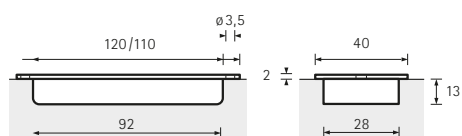

Essa



- 1 Cínový vzhľad
Cínový vzhľad
Imitácia ciny
Ónhatású



- 2 Mosazný vzhľad antik
Mosazný vzhľad antik
Imitacja antycznego mosiądzu
Sárgarézhatású, antik



- 3 Měděný vzhľad antik
Medený vzhľad antik
Imitacja antycznej miedzi
Rézhatású, antik



- 4 Cínový vzhľad antik
Cínový vzhľad antik
Imitacja antycznej ciny
Ónhatású, antik

Tonala



- Černá matná
Čierna matná
Czarny mat
Matt fekete

		☐
1	9 113 222	50
2	9 113 221	50
3	9 113 223	50
4	9 113 220	50

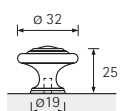

		☐
	9 266 561	50

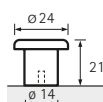

FOLK

Galleno



- 1 Chromovaná lesklá
Chrómovaná lesklá
Chrom poľsk
Krómozott, fényes



- 2 Niklovaná matná
Niklovaná matná
Nikel mat
Nikkelezett, matt



- 3 Nerezový vzhľad kartáčovaný
Nerez finiš kartáčovaný
Imitácia stali nierdzewnej szczotkowanej
Nemesacél-hatású, Szálcsiszolt

1	9 206 133	100	
2	9 112 599	100	
3	9 206 132	100	

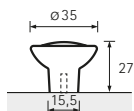

Fossa



- Cínový vzhľad
Cínový vzhľad
Imitácia cyny
Ónhatású

	9 112 646	100	
--	-----------	-----	--

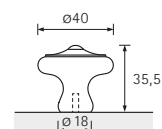

Solva



- 1 Mosazný vzhľad lesklý
Mosadzný vzhľad lesklý
Imitácia mosiáďžu poľsk
Sárgarézhatású, fényes



- 2 Mosazný vzhľad antik
Mosadzný vzhľad antik
Imitácia antycznego mosiáďžu
Sárgarézhatású, antik

1	9 070 575	75	
2	9 113 286	75	

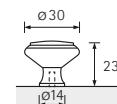

Altedo



- 1 Nerezový vzhľad kartáčovaný
Nerez finiš kartáčovaný
Imitacja stali nierdzewnej szczotkowanej
Nemesacél-hatású, Szálcsiszolt



- 2 Cínový vzhľad antik
Cínový vzhľad antik
Imitacja antycznej cyny
Ónhatású, antik



- 3 Černá matná
Čierna matná
Czarny mat
Fekete, matt

Larru



- Cínový vzhľad kartáčovaný
Cínový vzhľad kartáčovaný
Imitacja cyny szczotkowanej
Ónhatású, Szálcsiszolt

			☐
1	9 113 293	50	
2	9 204 153	50	
3	9 265 886	50	

			☐
	9 113 659	75	

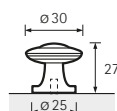
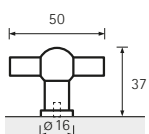

TOUCH-IN

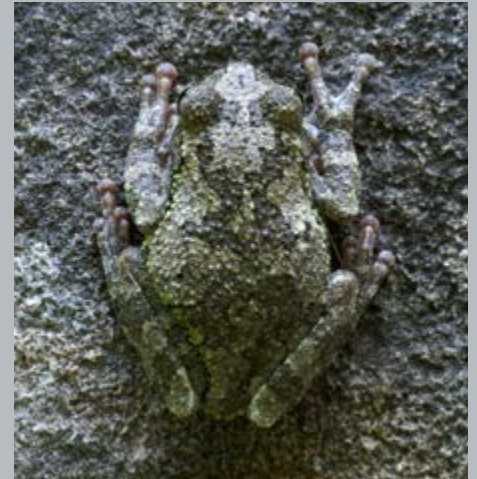

Nové perspektivy pro čistý design nábytku
Nové perspektivy pre čistý dizajn nábytku
Swoboda projektowania pod względem kształtu i koloru
Rugalmas a formai kialakításban és a színben

Neobvyklý zážitek

Nábytek takřka bez úchytek se pyšní rafinovaným řešením. Touch-in poskytuje volnost při tvorbě tvarů a barev. K dispozici jsou hotové úchytky hranatého nebo kulatého tvaru, s nerezovým nebo chromovaným vzhledem – stačí zabudovat. Modulární konstrukce ale umožňuje realizovat mnoho různých individuálních kombinací barev. Vnitřní dekorativní prvek se dá nalakovat nebo osadit dýhou. Úchytky Touch-in lze nalakovat barvou odpovídající čelní ploše nábytku nebo zadýhovat požadovaným dekorem.

Neobvyklý zážitok

Nábytok takmer bez úchytek sa pyši rafinovaným riešením. Touch-in poskytuje voľnosť pri tvorbe tvarov a farieb. K dispozícii sú hotové úchytky hranatého alebo okrúhleho tvaru, s nerezovým alebo chromovaným vzhľadom – stačí zabudovať. Modulárna konštrukcia ale umožňuje realizovať mnoho rôznych individuálnych kombinácií farieb. Vnútorňý dekoratívny prvok sa dá nalakovať alebo osadiť dýhou. Úchytky Touch-in možno nalakovať farbou zodpovedajúcou čelnej ploche nábytku alebo zadýhovať požadovaným dekórom.

Wyjątkowe doświadczenie dotyku

W wydających się pozbawionych uchwytów frontach ukryty jest genialnie prosty, a zarazem wyrafinowany Touch-in. Dzięki tym modułowym lub gotowym do montażu uchwytom, możecie Państwo tworzyć różnorodne warianty – czy to pod kolor frontu lub też kontrastujące. Uchwyty Touch-in mogą zostać polakierowane pod kolor frontu lub pokryte wybranym laminatem.

A fogantyúk által nyújtott különleges élmény

A Touch-in fogantyú funkcióval ellátott, szinte fogantyú nélkülinek tűnő front rendkívül egyszerű, de legalább annyira zseniális. A moduláris vagy beépítésre kész fogantyúk segítségével számtalan a fiókelőhöz illeszkedő, illetve attól elütő variáció alakítható ki. A Touch-in fogantyúkat a gyártó front színével, illetve igény szerinti színnel vonhatja be.

Touch-in hotové k zabudování
hotové na zabudovanie
gotowy do montażu
beépítésre kész



1 Chromovaná lesklá
Chrómovaná lesklá
Chrom połysk
Krómozott, fényes



2 Nerezový vzhľad kartáčovaný
Nerez finiš kartáčovaný
Imitacja stali nierdzewnej szczotkowanej
Nemesacél-hatású, kefével csiszolt



1 Chromovaná lesklá
Chrómovaná lesklá
Chrom połysk
Krómozott, fényes



2 Nerezový vzhľad kartáčovaný
Nerez finiš kartáčovaný
Imitacja stali nierdzewnej szczotkowanej
Nemesacél-hatású, kefével csiszolt

1	9 086 690	25
2	9 086 689	25

1	9 086 688	25
2	9 086 687	25

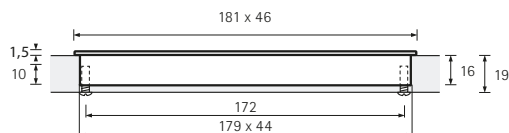
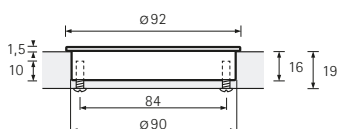

TOUCH-IN

Touch-in modulární modulárne modułowy moduláris



- 1 Chromovaná lesklá
Chrómovaná lesklá
Chrom potysk
Krómozott, fényes



- 2 Nerezový vzhled kartáčovaný
Nerez finiš kartáčovaný
Imitacja stali nierdzewnej szczotkowanej
Nemesacél-hatású, kefével csiszolt



- 1 Chromovaná lesklá
Chrómovaná lesklá
Chrom potysk
Krómozott, fényes



- 2 Nerezový vzhled kartáčovaný
Nerez finiš kartáčovaný
Imitacja stali nierdzewnej szczotkowanej
Nemesacél-hatású, kefével csiszolt

1	9 086 694	25	
2	9 086 693	25	

1	9 086 692	25	
2	9 086 691	25	

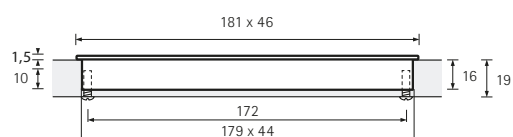
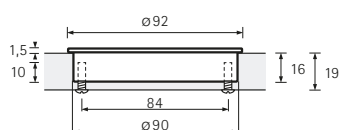

Touch-in modulární modulárne modułowy moduláris

Dekoratívny prvok (plast ABS) k nalakování
Dekoratívny prvok (plast ABS) pre nalakovanie
Panele dekoracyjne (ABS) do lakierowania
Festhető dekorelemek (ABS)



- 1 Plast bez povrchové úpravy
Plast bez povrchovej úpravy
Tworzywo sztuczne niepowleczone
Bevonat nélküli műanyag



- 1 Plast bez povrchové úpravy
Plast bez povrchovej úpravy
Tworzywo sztuczne niepowleczone
Bevonat nélküli műanyag

Dekoratívny prvok pro použití dýhy
Dekoratívny prvok pre použitie dyhy
Panele dekoracyjne do zastosowania laminatu
Bevonható dekorelemek



- 2 Chromovaná lesklá
Chrómovaná lesklá
Chrom połysk
Krómozott, fényes



- 2 Chromovaná lesklá
Chrómovaná lesklá
Chrom połysk
Krómozott, fényes



- 3 Nerezový vzhled
Nerez finiš
Imitacja stali nierdzewnej
Nemesacél-hatású



- 3 Nerezový vzhled
Nerez finiš
Imitacja stali nierdzewnej
Nemesacél-hatású

1	9 086 698	25
2	9 086 702	25
3	9 086 701	25

1	9 086 695	25
2	9 086 697	25
3	9 086 696	25

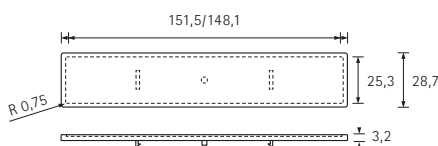
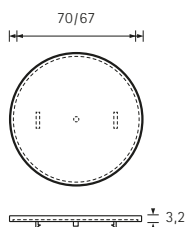

TOUCH-IN

Touch-in modulární modulárne modułowy moduláris

Dekoratívni prvek (plast ABS) k nalakování
Dekoratívny prvok (plast ABS) pre nalakovanie
Panele dekoracyjne (ABS) do lakierowania
Festhető dekorelemek (ABS)

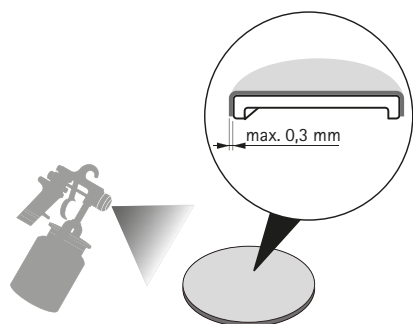

Dekoratívni prvek pro použití dýhy
Dekoratívny prvok pre použitie dyhy
Panele dekoracyjne do zastosowania laminatu
Bevonható dekorelemek

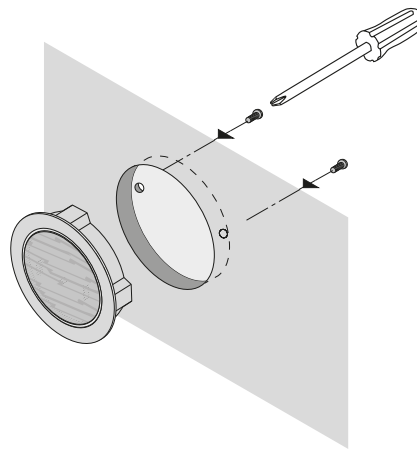
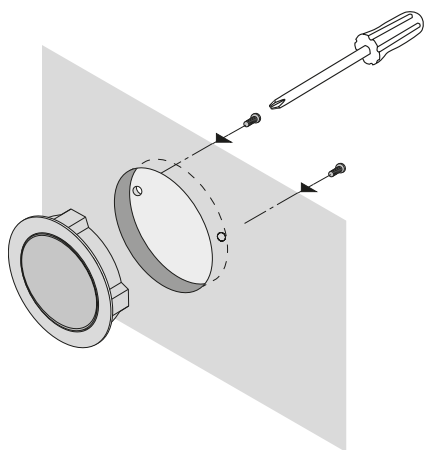
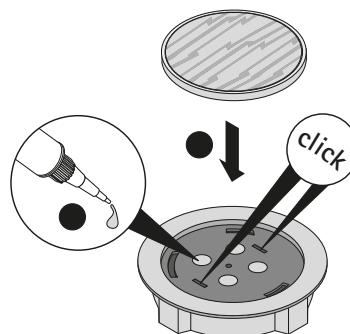
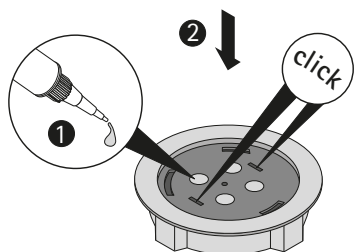
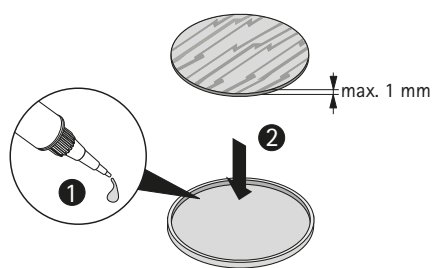

doporučené lepidlo: 2K SE Polymer např. JOWAT 690.00
odporúčané lepidlo: 2K SE Polymer napr. JOWAT 690.00
zalecany klej: 2K SE polimer, np. JOWAT 690.00
ajánlott ragasztóanyag: 2K SE Polymer, pl. JOWAT 690.00

Dekoratívny prvok (plast ABS) k nalakování
 Dekoratívny prvok (plast ABS) pre nalakovanie
 Panele dekoracyjne (ABS) do lakierowania
 Festhető dekorelemek (ABS)

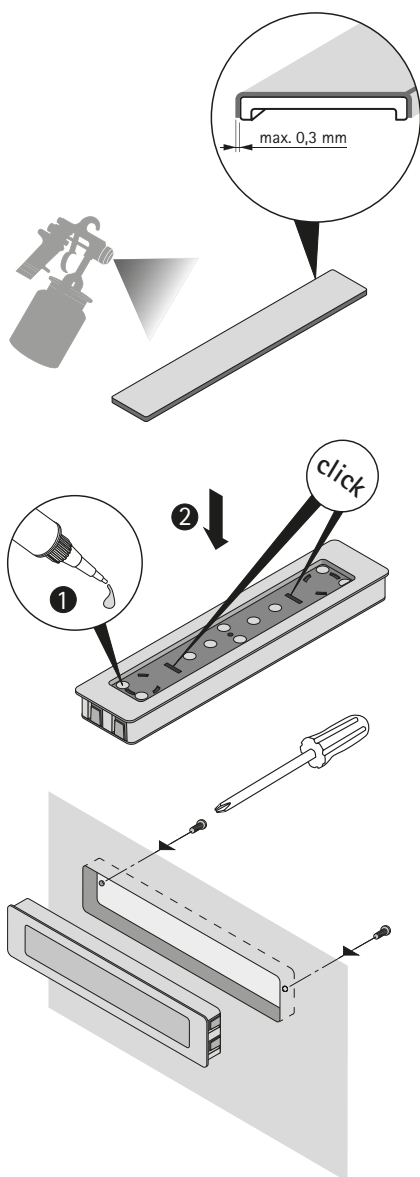

Dekoratívny prvok pro použití dýhy
 Dekoratívny prvok pre použitie dyhy
 Panele dekoracyjne do zastosowania laminatu
 Bevonható dekorelemek

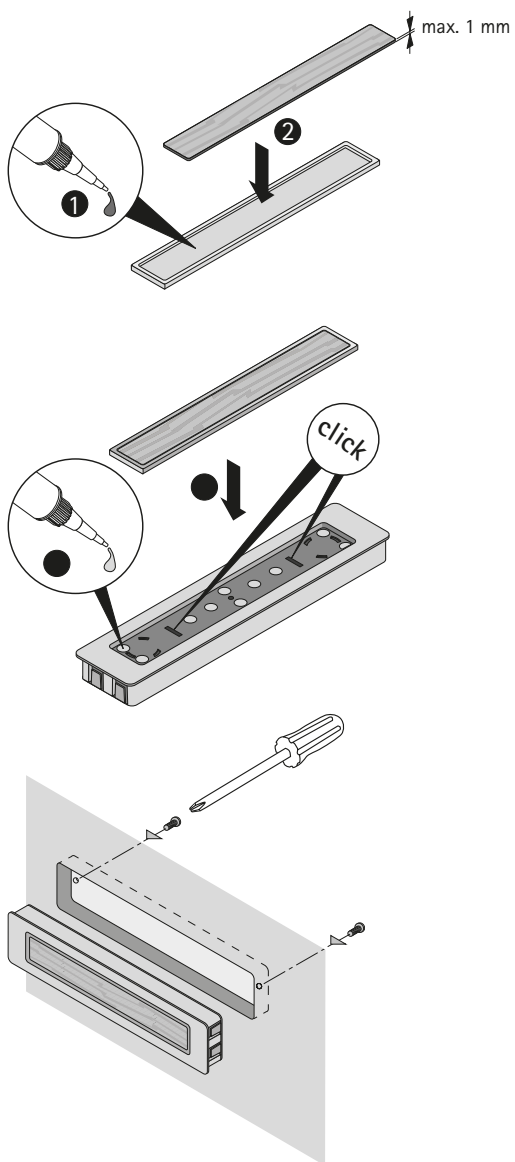

SERVICE

Služby Hettich:
Kompetence online

Služby Hettich:
Kompetencia online

Serwis Hettich:
Wsparcie w sieci

Hettich Service:
Szakértelem a hálón



Nové nápady realizujte hospodárně a vylepšujte ty vyzkoušené!

Hettich vás podporuje online. Od inspirace přes navrhování nábytku a výběr správného kování až po efektivní realizaci. Na www.hettich.com najdete spoustu inspirace. Odpovídající kování je rychle k dispozici v online katalogu: od základního přehledu až po podrobné informace.

Pro přesné a snadné navrhování nábytku s kovááním Hettich můžete využít nástroj HettichPlan a web DesignGallery s konkrétními realizacemi jakož i knihovny Hettich CAD. S montáží a seřizením kování Hettich Vám poradí aplikace Hettich Technical Assistant.

Nové nápady realizujte hospodárne a vylepšujte tie vyzkúšané!

Hettich vás podporuje online. Od inšpirácie cez navrhovanie nábytku a výber správneho kovania až po efektívnu realizáciu. Na www.hettich.com nájdete kopu inšpirácie. Vhodné kovanie je rýchlo k dispozícii v online katalógu: od základného prehľadu až po podrobné informácie.

Pre presné a jednoduché navrhovanie nábytku s kovaním Hettich môžete využiť nástroj HettichPlan a web DesignGallery s konkrétnymi realizáciami ako aj knižnice Hettich CAD. S montážou a nastavením kovania Hettich Vám poradí aplikácia Hettich Technical Assistant.



Aplikace Hettich:

Naši aplikaci pro mobilní telefony a tablety získáte bezplatně v příslušném online obchodě

Aplikácie Hettich:

Našu aplikáciu pre mobilné telefóny a tablety získate bezplatne v príslušnom online obchode

Aplikacja Hettich:

Nasza aplikacja dostępna jest w podanych poniżej sklepach online

Hettich alkalmazás:

Az alkalmazásunk megtalálható bármelyik online áruházban



Celý výrobní program, další technické údaje a dodatečné informace naleznete v Hettich online katalogu.

Celý výrobný program, ďalšie technické údaje a dodatočné informácie nájdete v online katalógu Hettich.

W Katalogu online znajdziecie Państwo kompletny asortyment, szczegóły techniczne oraz dodatkowe informacje.

A teljes termékprogramot, további műszaki adatokat és egyéb szükséges információkat a Hettich online katalógusban találja.



Realizacja optymalnych kosztowo, nowych projektów mebli i stałe ulepszanie sprawdzonych rozwiązań!

Hettich wspiera Państwo online, począwszy od znalezienia pomysłów, poprzez projektowanie korpusów meblowych i dobór odpowiednich okuć meblowych, aż po samą realizację. Na stronie www.hettich.com znajdziecie Państwo mnóstwo inspiracji. Odpowiednie okucia do nich można szybko znaleźć w Katalogu online – od ogólnego przeglądu po szczegółowe informacje.

Możecie Państwo korzystać z naszych różnych narzędzi, aby dokładnie i w prosty sposób projektować meble z okuciami Hettich: Hettich Plan do projektowania korpusów meblowych, Galeria Inspiracji z gotowymi realizacjami, a także biblioteki okuć Hettich CAD. Asystent Techniczny firmy Hettich służy Państwu pomocą przy montażu i regulacji okuć.

Az új bútorötletek gazdaságos megvalósítása és megóvása a folyamatos javítással!

Hettich támogatja Önt online az ötlet megszületésétől a korpusz konkrét tervezésén és a megfelelő bevonat kiválasztásán át egészen a hatékony kialakításig. A www.hettich.com oldalon számtalan ötletet talál. A megfelelő bevonat, valamint a részletes információk éppen ezért az online katalógusban a termék első áttekintésekor gyorsan megtalálhatók.

Annak érdekében, hogy pontosan és hatékonyan tervezhessen a Hettich bevonatokkal, a rendelkezésére áll a HettichPlan korpusztervező, a Design Gallery, amely konkrét támogatást nyújt, valamint a Hettich CAD bevonatkönyvtár. A Hettich műszaki asszisztens segít Önnek a Hettich termékek összeszerelése és beállítása során.

SERVICE

Upevňovací materiál Upevňovací materiál Elementy mocujúce Rögzítőanyag

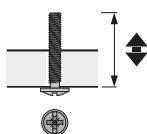

Šrouby pro montáž úchytek
s drážkou pro křížový i plochý
šroubovák ocel pozinkovaná

Skrutky pre montáž úchytiek
s drážkou pre křížový aj plochý
skrutkovač ocel pozinkovaná

Wkręty mocujące do uchwytyów
z nacięciem krzyżowym i prostym
Stal ocynkowana

Horganyzott acél,
csillagfejű fogantyú-
rögzítőcsavar

∅xL	∅	∅
M 4 x 12	0 071 544	50
M 4 x 14	0 071 545	50
M 4 x 16	0 071 546	50
M 4 x 18	0 071 547	50
M 4 x 20	0 071 548	50
M 4 x 22	0 071 549	50
M 4 x 24	0 071 555	50
M 4 x 26	0 071 556	50
M 4 x 28	0 071 557	50

∅xL	∅	∅
M 4 x 30	0 071 558	50
M 4 x 32	0 071 559	50
M 4 x 34	0 071 560	50
M 4 x 36	0 071 561	50
M 4 x 38	0 071 562	50
M 4 x 40	0 071 563	50
M 4 x 42	0 071 855	50
M 4 x 45	0 071 856	50

Univerzální šroub pro montáž úchytek
M4 x 45 mm s drážkou pro křížový
i plochý šroubovák, lze zkrátit na 40, 35,
30, 25 nebo 20 mm, ocel pozinkovaná

Univerzálna skrutka pre montáž úchytiek
M4 x 45 mm s drážkou pre křížový
i plochý skrutkovač, možno skrátiť na 40,
35, 30, 25 alebo 20 mm, ocel pozinkovaná
Uniwersalny wkręt mocujący do uchwy-
tów M4 x 45 mm z nacięciem krzyżowym
i prostym, możliwość skrócenia do 40, 35,
30, 25 lub 20 mm, stal ocynkowana
Horganyzott acél univerzális M4 x 45
keresztfejű fogantyú-rögzítőcsavar,
amely 40, 35, 30, 25 vagy 20 mm hosz-
szúra rövidíthető



	∅	∅
	9 212 860	100



1 Aluminium finish
Hlinikový vzhľad
Imitácia aluminium
Aluminiumhatású

Príchytká se závitom M4
pro kožené úchytky
Gela a Galati
Zinek



2 Chromovaná lesklá
Chrómovaná lesklá
Chrom połysk
Krómzott, fényes

Príchytká so závitom M4
pre kožené úchytky
Gela a Galati
Zinek



3 Vzhľad niklovaná matná
Vzhľad niklovaný matný
Imitácia nikel mat
Nikkelezett, matt hatású

Mocowanie z gwintem M4
do uchwytyów skórzanych
Gela i Galati
Cynk



4 Bronzový vzhľad antik
Bronzový vzhľad antik
Imitácia antycznego brązu
Bronzhatású, antik

Rögzítő aljzat
M4 menettel a bőrfogantyúhoz
Gela és Galati
Ón

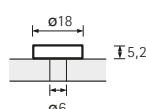

	∅	∅
1	9 113 651	200
2	9 113 652	200
3	9 113 653	200
4	9 113 654	200

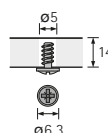

Speciální šroub pro koženou úchytku Nica
pro průměr vrtání 5 mm
s křížovou drážkou PZ, ø 6,3 x 14 mm
ocel pozinkovaná

Špeciálna skrutka pre koženú úchytku Nica
pre priemer vrtania 5 mm
s křížovou drážkou PZ, ø 6,3 x 14 mm
ocel pozinkovaná

Wkręt specjalny do uchwyty skórzanego Nica
dla średnicy wiercenia 5 mm
z nacięciem krzyżowym PZ ø 6,3 x 14 mm
Stal ocynkowana

Különleges csavar a Nica bőrfogantyúhoz
5 mm furat
PZ csillagfej ø 6,3 x 14 mm
horganyzott acél

	∅	∅
	0 046 700	200

Distanční pouzdro pro montáž úchytek na skleněná dvířka
Dišťančné puzdro pre montáž úchytek na sklenené dverka
Tuleja dystansowa do frontów szklanych
Távtartó perselyek az üvegajtókhöz



Distanční pouzdro pro upevnění úchytky na skleněné dveře
 Plast
 Dišťančné puzdro pre upevnenie úchytky na sklenené dverke
 Plast
 Tuleja dystansowa do zamocowania uchwyty do frontu szklanego
 Tworzywo sztuczne
 Távtartó perselyek az üvegajtók fogantyúrgzéséhez
 Műanyag

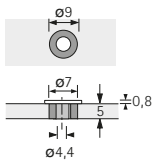

	□
9 113 347	100

Adaptér pro skládané dveře
Adaptér pre skladané dvere
Adapter do drzwi składano-przesuwnych
Adapter a harmonikás tolóajtókhöz



1 Chromovaná matná
 Chromovaná matná
 Chrom mat
 Krómozott, matt



2 Niklovaná matná
 Niklovaná matná
 Nikiel mat
 Nikkelezett, matt



Plastová podložka
 Plastová podložka
 Podkładka z tworzywa sztucznego
 Műanyag alátét

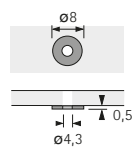

	□
9 077 861	1000

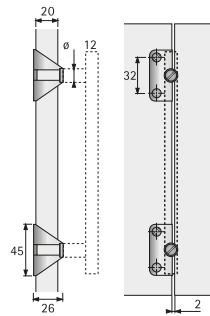

Lze použít pro úchytky na dvířkách tloušťky max. 20 mm a s dosadací plochou úchytky větší než \varnothing 12 mm.
 Można použít pre úchytky na dverkach hrúbky max. 20 mm a s dosadacou plochou úchytky väčší než \varnothing 12 mm.
 Zastosowanie dla wszystkich rozwiązań uchwytych dla drzwi o grubości max. 20 mm i powierzchni przylegania uchwyty minimum \varnothing 12 mm.
 Minden fogantyúmegoldáshoz használható, ahol az ajtóvastagság legfeljebb 20 mm és a fogantyú kiemelkedési felülete legalább \varnothing 12 mm.

		□
1	0 115 365	100
2	0 115 366	100

SERVICE

Vrtací šablony Accura Vŕtacie šablóny Accura Szablon do nawierceń Accura Accura fúróvezető

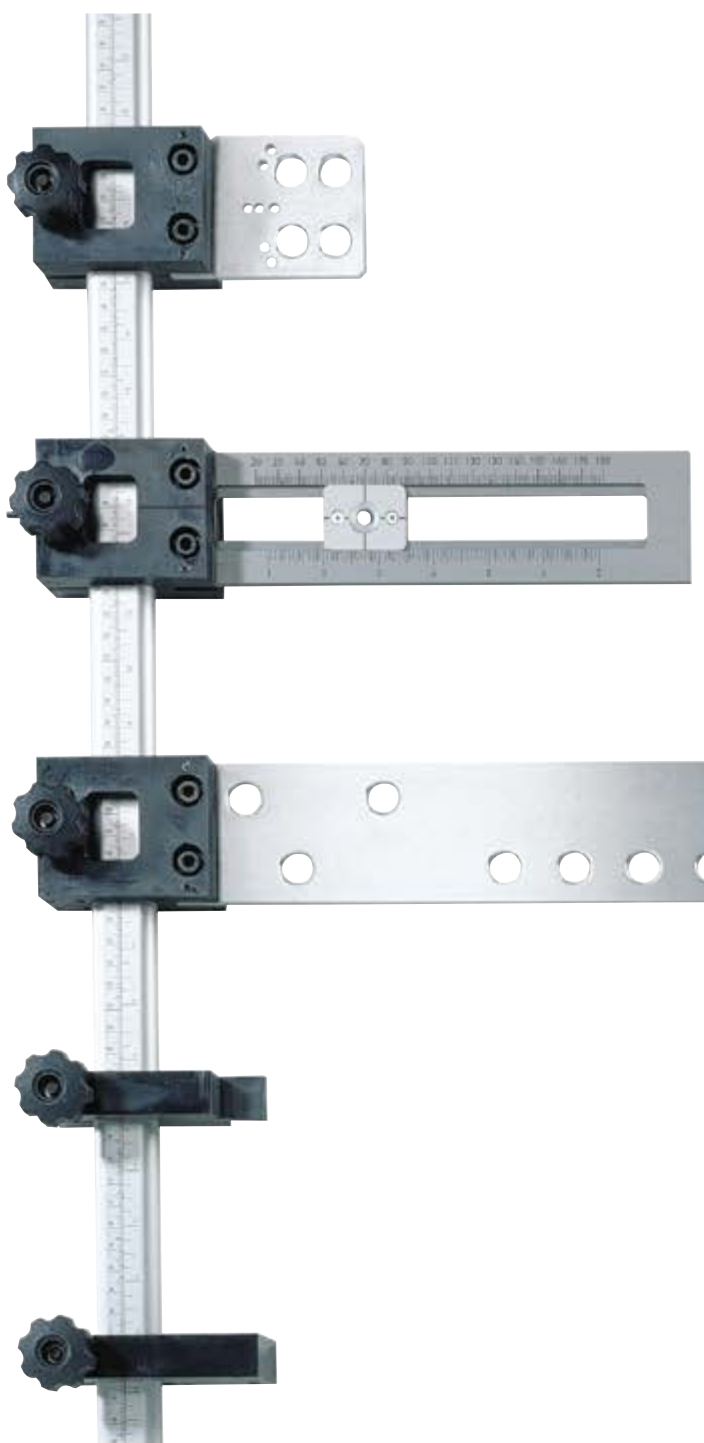

Accura - racionální, hospodárná a profesionální univerzální vrtací šablona

Accura - racionalna, hospodarna a profesionalna univerzalna vŕtacia šablóna

Accura - efektywny, ekonomiczny i profesjonalny szablon do nawierceń z systemem modułowym

Accura - a racionális, gazdaságos és szakszerű univerzális fúróvezető a szekrényépítésben

Vrtací těleso Accura pro úchytky

Vŕtacie teleso Accura pre úchytky

Szablon Accura do uchwytów

Accura-fúrótest a fogantyúkhöz

Různá vrtací tělesa a dorazy se dají libovolně polohovat na liště Accura se stupnicí v mm a v palcích (délky 500 až 2000 mm).

Rôzne vŕtacie telesá a dorazy sa dajú ľubovoľne polohovať na lište Accura so stupnicou v mm a v palcoch (dĺžky 500 až 2000 mm).

Na szynie Accura ze skalą w mm oraz calach (długości od 500 do 2000 mm) można dowolnie rozmieszczać różne szablony i ograniczniki.

A különböző fúrótestek és ütőközök az Accura-sínen mm és hüvelyk skálával is beállíthatók (500 és 2000 mm között).

Značky pro vrtání v rozteči 32 mm.

Značky pre vŕtanie v rozstupe 32 mm.

Oznaczenie dla nawierceń w Systemie 32.

A jelölés a furatok számára 32-es rászterben.

Vrtací těleso Accura pro úchytky
Vrtacie teleso Accura pre úchytky
Szablon Accura do uchwytów
Accura-fúrótest a fogantyúkhöz

Accura, sada pro úchytky obsahuje:

- 2 vrtací tělesa Accura pro úchytky
- 2 vrtací podložky s vodícím pouzdrum pro vrták z rychlořezné oceli prům. 5 mm
- 1 lištu Accura se stupnicí v mm a palcích, délka 500mm
- 1 stavitelný doraz pro čela zásuvek a dvířka

② Lišta Accura se stupnicí v mm a v palcích, se značkami v rozteči 32 mm

- 500 mm
- 1000 mm
- 1500 mm
- 2000 mm

③ Vrtací těleso Accura pro úchytky, včetně vrtací podložky s vodícím pouzdrum pro vrták z rychlořezné oceli o prům. 5 mm, hliník / plast

④ Náhradní destička s vrtacím pouzdrum pro vrtací těleso Accura na úchytky

⑤ Spirálový vrták 5 mm

⑥ Stavitelný doraz pro dvířka / čela zásuvek a jednotlivé (demontované) boky korpusu, plast

Accura, sada pro úchytky obsahuje:

- 2 vrtacie telesá Accura pre úchytky
- 2 vrtacie podložky s vodiacim puzdrom pre vrták z rýchlořeznej ocele priem. 5 mm
- 1 lištu Accura so stupnicou v mm a palcoch, dĺžka 500mm
- 1 nastaviteľný doraz pre čelá zásuviek a dvierka

② Lišta Accura so stupnicou v mm a v palcoch, so značkami v rozstupe 32 mm

- 500 mm
- 1000 mm
- 1500 mm
- 2000 mm

③ Vrtacie teleso Accura pre úchytky, vrátane vrtacej podložky s vodiacim puzdrom pre vrták z rýchlořeznej ocele o priem. 5 mm, hliník / plast

④ Náhradná podložka s vrtacím puzdrom pre vrtacie teleso Accura na úchytky

⑤ Špirálový vrták 5 mm

⑥ Nastaviteľný doraz pre dvierka / čelá zásuviek a jednotlivé (demontované) boky korpusu, plast

Szablon Accura, zestaw do uchwytów składa się z:

- 2 szablonów Accura do nawierceń pod uchwyt
- 2 płytek z tuleją prowadzącą do wiertła krętego ze stali HSS 5 mm
- 1 szyny Accura ze skalą w mm i calach, długość 500 mm
- 1 przesuwnego ogranicznika do frontów

② Szyna Accura ze skalą w mm oraz calach, z oznaczeniem dla nawierceń w Systemie 32

- 500 mm
- 1000 mm
- 1500 mm
- 2000 mm

③ Szablon Accura do uchwytów, wraz z płytką do nawierceń z tuleją prowadzącą do wiertła krętego HSS 5 mm aluminium/tworzywo sztuczne

④ Dodatkowy znacznik z otworem do nawierceń do szablonu Accura do uchwytów

⑤ Wiertło kręte 5 mm

⑥ Przesuwny ogranicznik do frontów i pojedynczych (rozłożonych) boków korpusu, tworzywo sztuczne

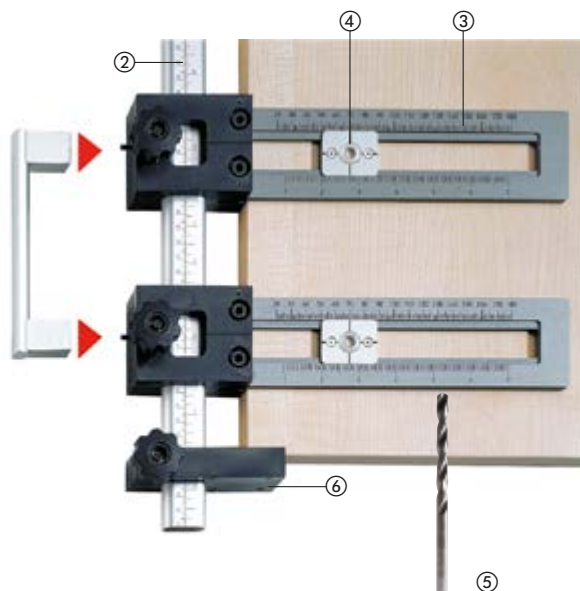

Accura-fúróvezető, készlet a fogantyúkhöz részei:

- 2 Accura-fúrótest a fogantyúkhöz
- 2 fúrólemez vezetőpersellyel az 5 mm-HSS-spirálfúróhoz
- Accura-sín mm és hüvelyk méreetskálával, hossz: 500mm
- 1 állítható a frontokhoz

② Accura-sín mm és hüvelyk méreetskálával,

„Raster 32” jelölő pontokkal

- 500 mm
- 1000 mm
- 1500 mm
- 2000 mm

③ Accura-fúrótest a fogantyúkhöz, beleértve a vezetőperselyes fúrólemez az 5 mm-HSS-spirálfúróhoz, alumínium/műanyag

④ Tartalék toló fúrópersellyel az Accura-fúrótesthez a fogantyúk számára

⑤ 5 mm spirálfúró

⑥ Állítható a frontokhoz és az egyes (szétszerelt) oldallapokhoz, műanyag

	•	□
2	500	0 044 763 1
2	1000	0 070 263 1
2	1500	0 070 264 1
2	2000	0 020 014 1
3		0 044 765 1
4		0 044 767 1
5		0 044 766 1
6		0 070 266 1

SERVICE

Vrtací těleso Accura pro úchytky
Vŕtacie teleso Accura pre úchytky
Szablon Accura do uchwytów
Accura-fúrótest a fogantyúkhöz

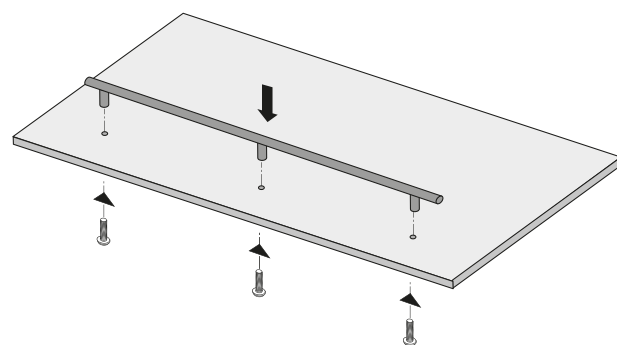
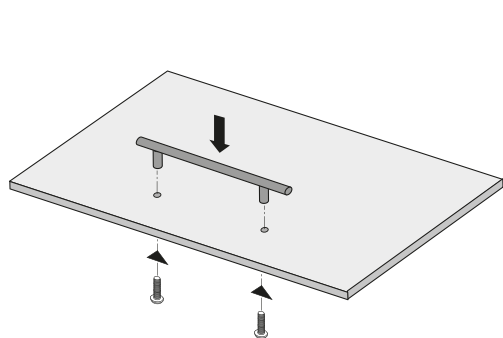
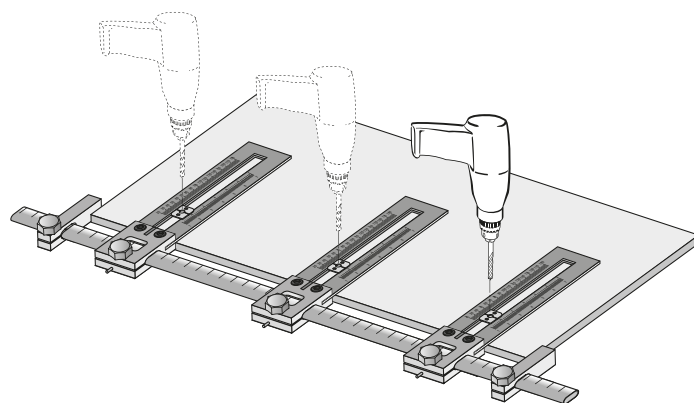
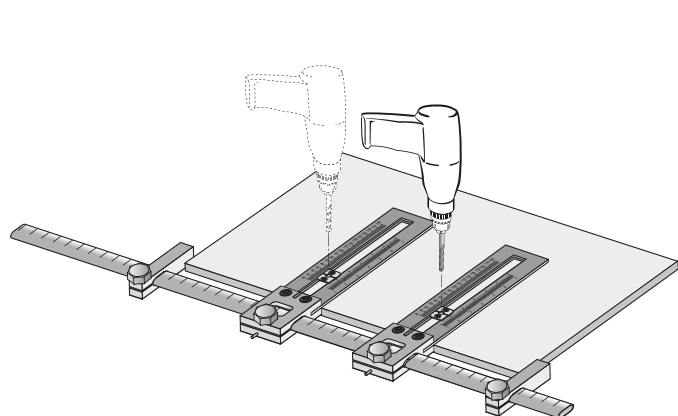
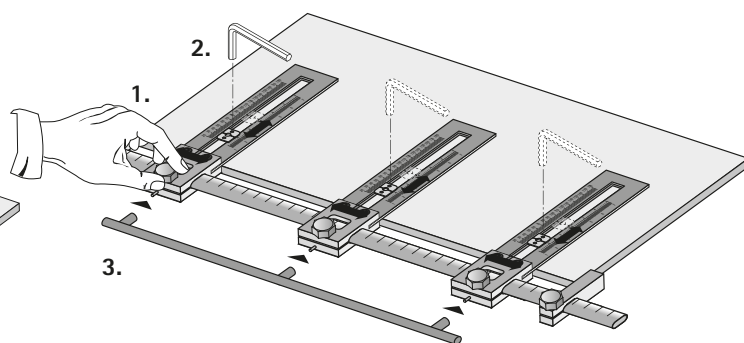
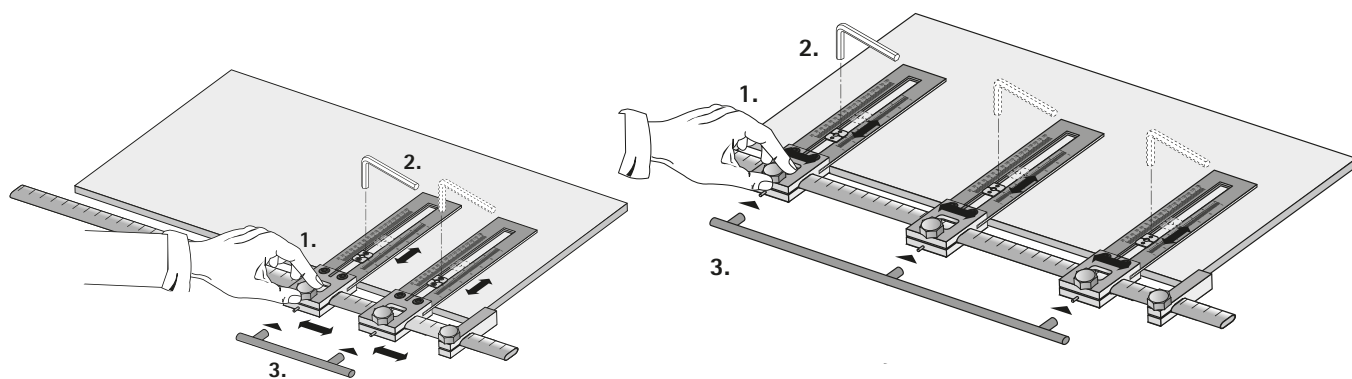

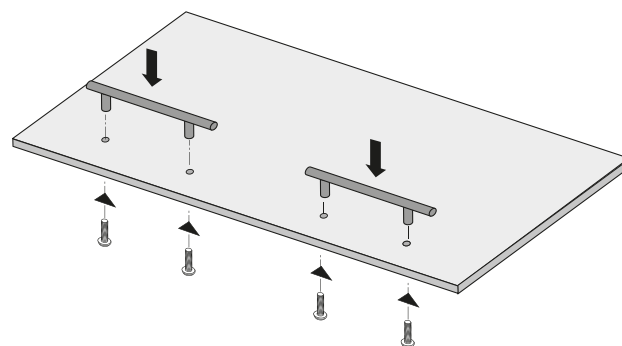
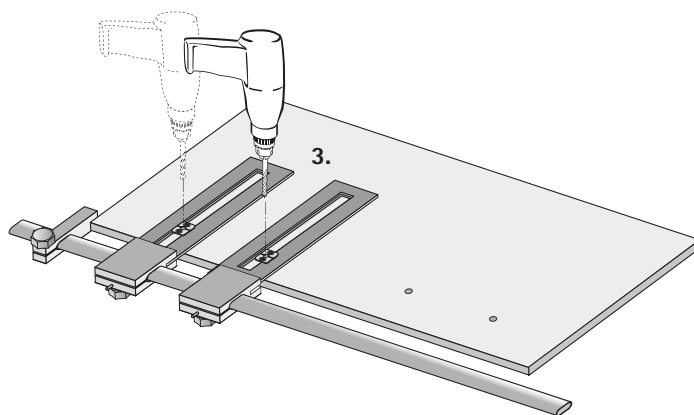
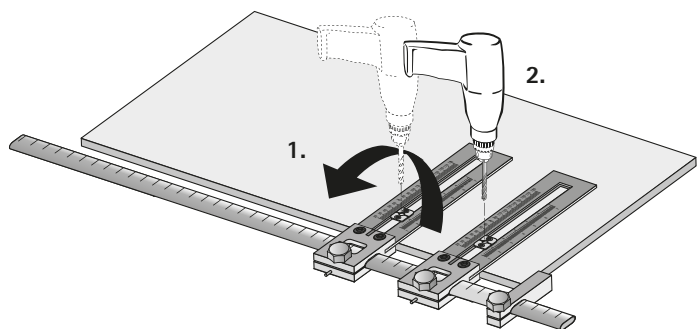

- Nastavit požadovanou polohu
- Nastavit rozteč otvorů a zkontrolovat pomocí přenášečích čepů
- Pro úchytku s 2 nebo 3 patkami: přiložit seřízenou šablonu a vyvrtat otvory
- Přišroubovat úchytku

- Nastavit požadovanú polohu
- Nastaviť rozstup otvorov a skontrolovať pomocou prenášacích čapov
- Pre príchytku s 2 alebo 3 pátkami: priložiť nastavenú šablónu a vyvrtáť otvory
- Priskrutkovať úchytku

- Ustawić rozmieszczenie uchwytów na froncie
- Ustawić rozstaw nawierceń i sprawdzić za pomocą trasera
- Przy uchwycie z 2 lub 3 stopkami: przyłożyć ustawiony szablon i wykonać wiercenia
- Przykręcić uchwyt

- Állítsa be az elülső oldalon a kivánt helyzetet
- Állítsa be a furatok távolságát és ellenőrizze a fogantyúkkal
- Egy 2 vagy 3 aljzatos fogantyú esetén: Helyezze fel a beállított fúróvezetőt és fúrjon
- Csavarozza fel a fogantyút

Dvě symetricky umístěné úchytky: přiložit šablonu na jednu stranu a vyvrtat otvory pro 1. úchytku, poté otočit šablonu bez změny nastavení a vyvrtat otvory pro 2. úchytku.

Dve symetricky umiestnené úchytky: priložiť šablónu na jednu stranu a vyvrtáť otvory pre 1. úchytku, potom otočiť šablónu bez zmeny nastavenia a vyvrtáť otvory pre 2. úchytku.

Przy dwóch uchwytach rozstawionych symetrycznie: Przyłożyć szablon do jednej strony i wywiercić otwory pod 1. uchwyt, następnie obrócić szablon przykładając do drugiej strony i wywiercić otwory pod 2. uchwyt.

Két szimmetrikusan elhelyezett fogantyú esetén: Helyezze a fúróvezetőt először az egyik oldalra és fúrja ki az 1. fogantyú furatát, majd a fúróvezetőt az átállítása nélkül helyezze át a másik oldalra, és fúrja ki a 2. fogantyú furatát.

SERVICE

Univerzální označovací šablona pro úchytky
Univerzálna označovacia šablóna pre úchytky
Uniwersalny szablon do punktowania pod uchwyty i gałki
Univerzális jelölőszablon a fogantyúkhöz és a gombokhoz

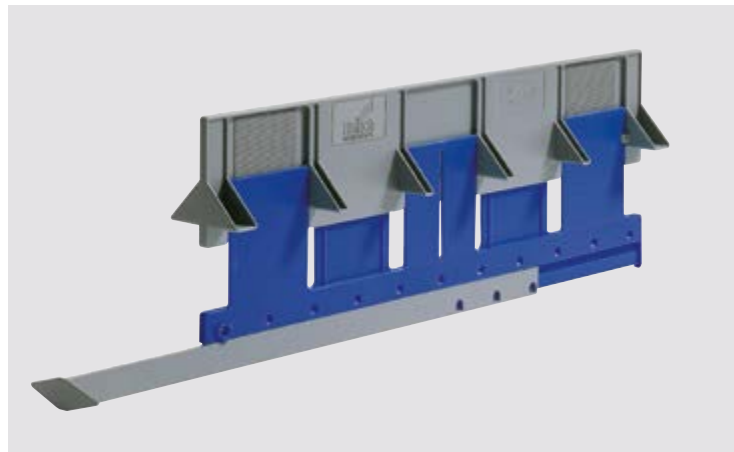

Označovací šablona se seřízením ve dvou osách pro rychlé a přesné označení polohy otvorů v Systému 32 pro

- Úchytky (rozeč otvorů 32-320 mm)
- Knoflíkové úchytky

Rozsah seřízení: • Vzdálenost od boční hrany čela zásuvky po první montážní otvor úchytky 10-334 mm
 • Vzdálenost od horní nebo dolní hrany čela po úchytku 20-65 mm

Označovacia šablóna s nastavením vo dvoch smeroch pre rýchle a presné označenie polohy otvorov v Systéme 32 pre

- Úchytky (rozstup otvorov 32-320 mm)
- Gombíkové úchytky

Rozsah nastavenia: • Vzdialenosť od bočnej hrany čela zásuvky po prvý montážny otvor úchytky 10-334 mm
 • Vzdialenosť od hornej alebo dolnej hrany čela po úchytku 20-65 mm

2-płaszczyznowy szablon do szybkiego i dokładnego punktowania nawierceń w Systemie 32 pod

- Uchwyty (rozstaw nawierceń 32-320 mm)
- Gałki

Zakres regulacji: • Odległość bocznej krawędzi frontu do pierwszego wiercenia pod uchwyt 10-334 mm
 • Odległość górnej/dolnej krawędzi frontu do uchwytu 20-65 mm

Két dimenzióban állítható jelölőszablon a furatok helyének gyors és pontos bejelöléséhez a 32 rendszerben a

- fogantyúk számára (furattávolság 32-320 mm)
- gombok számára

Beállítási tartomány: • A lap oldalszegélyének távolsága a fogantyú első rögzítő furatáig 10-334 mm
 • A lap alsó/felső szegélyének távolsága a fogantyú helyzetétől 20-65 mm

0 048 771 1

Nastavení polohy od horní hrany
 Nastavenie polohy od hornej hrany
 Ustawienie w pionie
 Magasságállítás

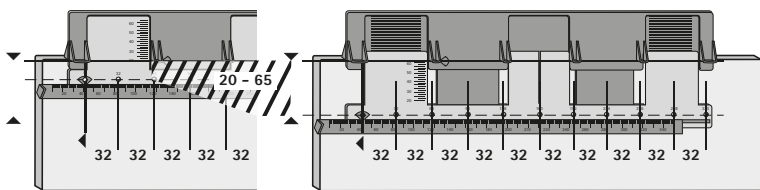

Vzorce pro výpočet
Vzorce na výpočet
Wzory obliczeniowe
Számítási képletek

Určení polohy úchytky
 Určenie polohy úchytky
 Ustawienie w poziomie dla uchwytu
 Egy fogantyú oldalsó elhelyezése

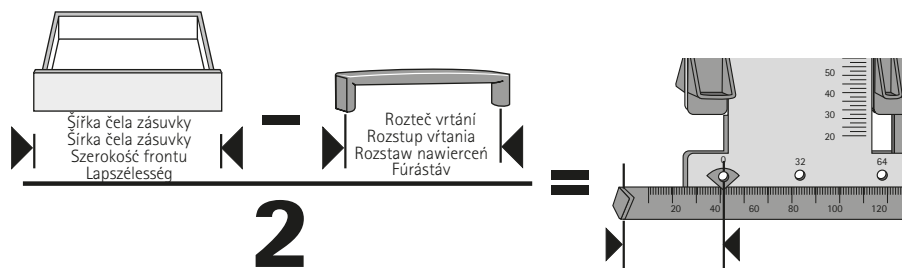

Vzdálenost od boční hrany čela zásuvky po první montážní otvor úchytky (min. 10 mm / max. 334 mm)
 Vzdialenosť od bočnej hrany čela zásuvky po prvý montážny otvor úchytky (min. 10 mm / max. 334 mm)

Odległość bocznej krawędzi frontu do pierwszego wiercenia mocującego uchwyt (min. 10 mm / max. 334 mm)
 A lap oldalszegélyének távolsága a fogantyú első rögzítő furatáig (min. 10 mm / max. 334 mm)

Určení polohy knoflíkové úchytky
 Určenie polohy gombikovej úchytky
 Ustawienie w poziomie dla gałki
 Egy gomb oldalsó elhelyezése

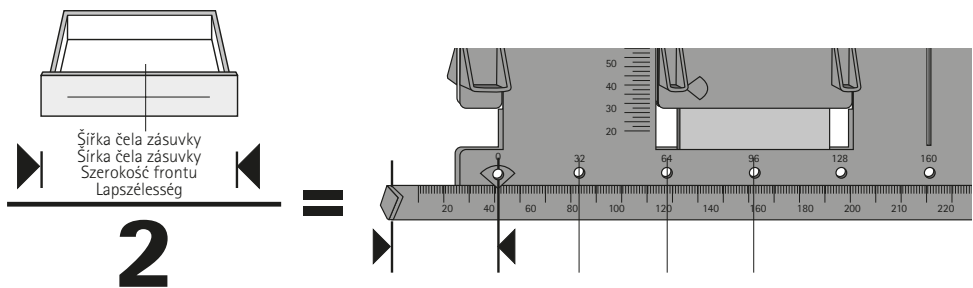

Vzdálenost od boční hrany čela zásuvky po montážní otvor knoflíkové úchytky (min. 10 mm / max. 334 mm)
 Vzdialenosť od bočnej hrany čela zásuvky po montážny otvor gombikovej úchytky (min. 10 mm / max. 334 mm)

Odległość bocznej krawędzi frontu do wiercenia mocującego gałkę (min. 10 mm / max. 334 mm)
 A lap oldalszegélyének távolsága a gomb rögzítő furatáig (min. 10 mm / max. 334 mm)

Nastavení polohy od boční hrany
 Nastavenie polohy od bočnej hrany
 Regulacja ustawienia w poziomie
 Oldalbeállítás

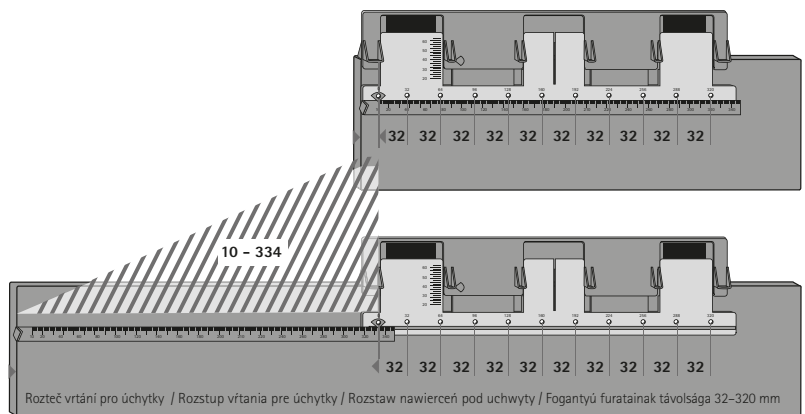

SERVICE

Univerzální označovací šablona pro úchytky Univerzálna označovacia šablóna pre úchytky Uniwersalny szablon do punktowania pod uchwyty i gałki Univerzális jelölőszablon a fogantyúkhöz és a gombokhoz

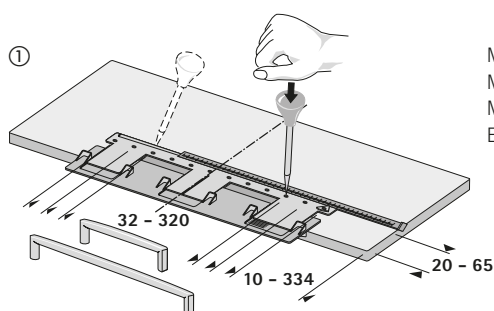

Montáž jedné úchytky
Montáž jednej úchytky
Montaż – jeden uchwyt
Egy fogantyú felszerelése

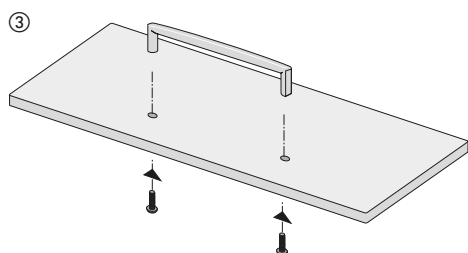
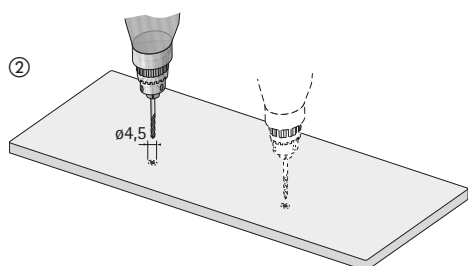

- ① Seřídít vrtací šablonu a označit polohu otvorů
- ① Nastaviť vrtáciu šablónu a označiť polohu otvorov
- ① Ustawić szablon i zaznaczyć miejsca nawierceń
- ① Állítsa be a jelölőszablont és jelölje meg a furatok helyét

- ② Vyvrtat otvory pro úchytku
- ② Vyvrtat otvory pre úchytku
- ② Wywiercić otwory montażowe
- ② Fúrja ki a rögzítő furatokat

- ③ Přišroubovat úchytku
- ③ Priskrutkovať úchytku
- ③ Przykręcić uchwyt
- ③ Csavarozza fel a fogantyút

Pro přesné přenesení polohy otvorů z pravé strany na levou stačí univerzální označovací šablónu přiložit obráceně.

Pre presné prenesenie polohy otvorov z pravej strany na ľavú stačí univerzálnu označovaciu šablónu priložiť obráteno.

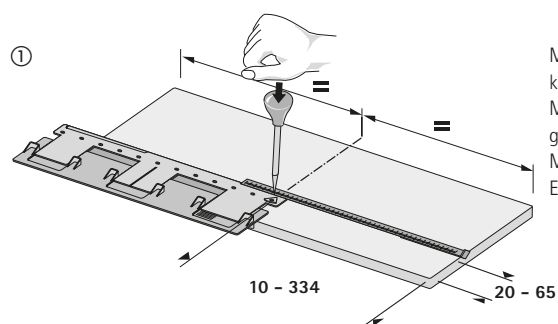

Montáž jedné knoflíkové úchytky
Montáž jednej gombíkovej úchytky
Montaż – jedna gałka
Egy gomb felszerelése

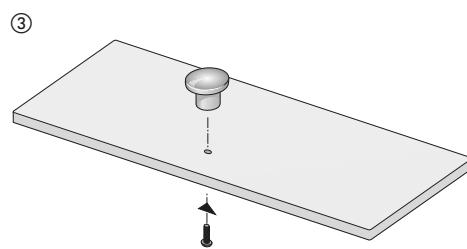
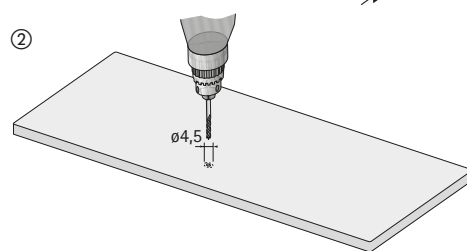

- ① Seřídít vrtací šablonu a označit polohu otvorů
- ① Nastaviť vrtáciu šablónu a označiť polohu otvorov
- ① Ustawić szablon i zaznaczyć miejsca nawierceń
- ① Állítsa be a jelölőszablont és jelölje meg a furatok helyét

- ② Vyvrtat otvory pro úchytku
- ② Vyvrtat otvory pre úchytku
- ② Wywiercić otwory montażowe
- ② Fúrja ki a rögzítő furatokat

- ③ Přišroubovat knoflíkovou úchytku
- ③ Priskrutkovať gombíkovú úchytku
- ③ Przykręcić gałkę
- ③ Csavarozza fel a gombot

Aby dokładnie przenieść schemat wierceń z prawej na lewą stronę, wystarczy przyłożyć obrócony szablon.

A fúrás hely pontos átviteléhez jobbról balra egyszerűen fordítsa meg az univerzális jelölőszablont.

Montáž dvou úchytek umístěných symetricky
 Montáž dvoch úchytek umiestnených symetricky
 Montaż – dwa uchwyty (rozstawione symetrycznie)
 Két fogantyú (szimmetrikus) felszerelése

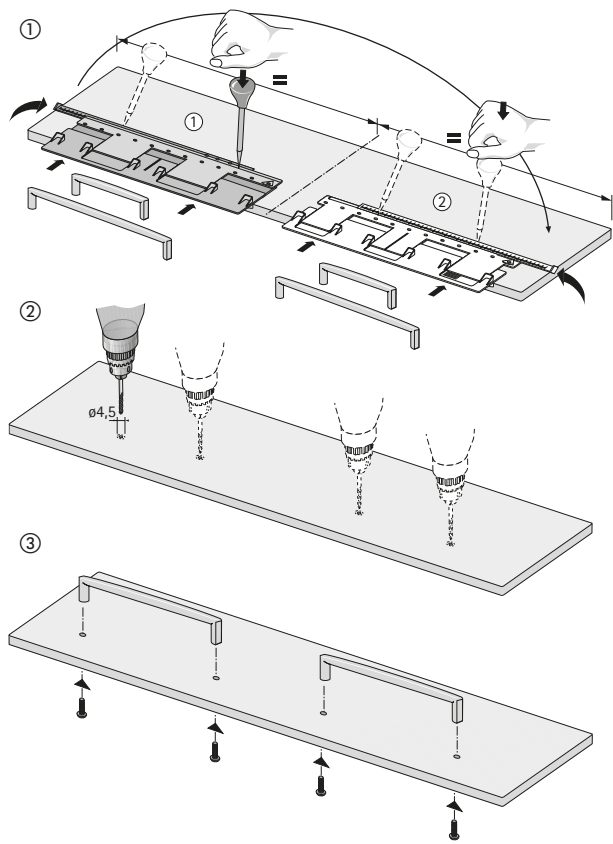

- ① Seřídít vrtací šablonu a označit polohu otvorů
- ① Nastaviť vrtáciu šablónu a označiť polohu otvorov
- ① Ustawić szablon i zaznaczyć miejsca nawierceń
- ① Állítsa be a jelölőszablont és jelölje meg a furatok helyét
- ② Vyvrtat otvory pro úchytku
- ② Vyvrtat' otvory pre úchytku
- ② Wywiercić otwory montażowe
- ② Fúrja ki a rögzítő furatokat
- ③ Přišroubovat úchytku
- ③ Priskrutkovať úchytku
- ③ Przykręcić uchwyt
- ③ Csavarozza fel a fogantyút

Pro přesné přenesení polohy otvorů z pravé strany na levou stačí univerzální označovací šablonu přiložit obráceně.
 Pre presné prenesenie polohy otvorov z pravej strany na ľavú stačí univerzálnu označovaciu šablónu priložiť obrátene.

Montáž dvou knoflíkových úchytek umístěných symetricky
 Montáž dvoch gombíkových úchytek umiestnených symetricky
 Montaż – dwie gałki (rozstawione symetrycznie)
 Két gomb (szimmetrikus) felszerelése

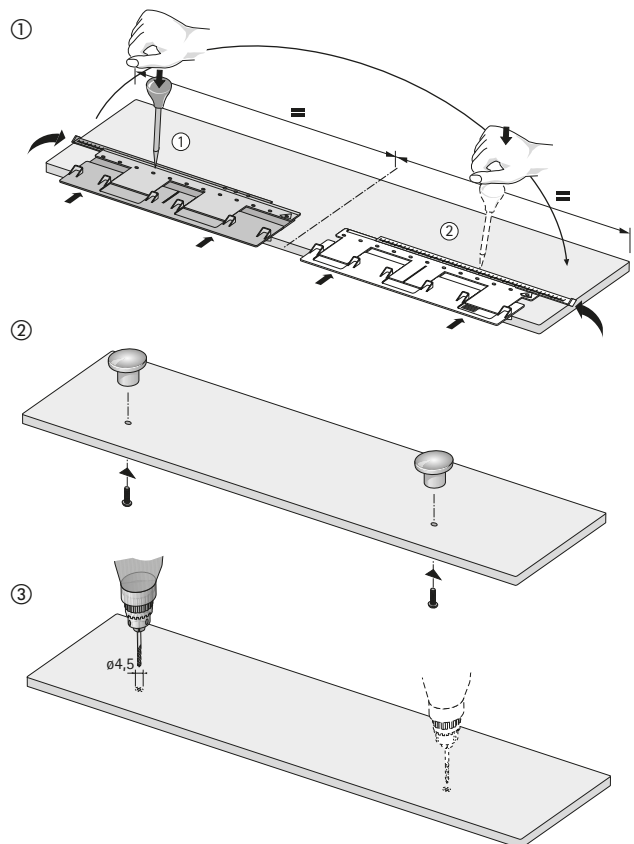

- ① Seřídít vrtací šablonu a označit polohu otvorů
- ① Nastaviť vrtáciu šablónu a označiť polohu otvorov
- ① Ustawić szablon i zaznaczyć miejsca nawierceń
- ① Állítsa be a jelölőszablont és jelölje meg a furatok helyét
- ② Vyvrtat otvory pro úchytku
- ② Vyvrtat' otvory pre úchytku
- ② Wywiercić otwory montażowe
- ② Fúrja ki a rögzítő furatokat
- ③ Přišroubovat knoflíkovou úchytku
- ③ Priskrutkovať gombíkovú úchytku
- ③ Przykręcić gałkę
- ③ Csavarozza fel a gombot

Aby dokładnie przenieść schemat wierceń z prawej na lewą stronę, wystarczy przyłożyć obrócony szablon.
 A fúrás hely pontos átviteléhez jobbról balra egyszerűen fordítsa meg az univerzális jelölőszablont.

INDEX

Prehled sortimentu podle materiálu
 Prehľad sortimentu podľa materiálov
 Przegląd produktów według materiału
 Anyagok szerint rendezett termékáttekintő

Ocel
 Ocel'
 Stal
 Acél



17 Hale



61 Nicia



68 Avenio



88 Valentia

Ocel a zinek
 Ocel' a zinok
 Stal i cynk
 Acél és cink



37 Misnia



88 Malaca

Zinek
 Zinok
 Cynk
 Cink



6 Vigilia



9 Evisa



10 Zenga



11 Nursia



12 Cheam



12 Tornea



16 Alvito



19 Fermo



26 Celisto



26 Genoa



27 Rialto



27 Messina



28 Milo



28 Venusia



35 Genzone



38 Novae



42 Amisia



42 Limpio



43 Istrana



43 Itri



44 Forli



45 Utinum



46 Baldone



46 Belluno



48 Intra



49 Veronia



49 Basilia



50 Arimini



50 Opera



50 Saturnia



51 Delia



51 Lodi



51 Sava



52 Solda



52 Londa



53 Fogo



53 Bona



56 Neapolis



56 Tolfo



56 Athena



57 Olivia



58 Felina



59 Coria



59 Parma



60 Balmo



60 Carvo



62 Bathia



62 Matilo



63 Salona



63 Ovada



64 Fectio



64 Vantania



65 Tolosa



65 Dinia



69 Belna



70 Lucca



71 Chalcis



71 Vieste



72 Suasa



72 Carolina



73 Trento



73 Meana



75 Tardiano



75 Ladera



75 Issa



76 Sala



76 Almus



77 Cirpi



80 Cato



80 Calili



81 Ponzone



81 Ponti



82 Corduba



82 Vesontio



82 Ponoka



82 Oka



83 Luro



83 Tarraco



83 Pomezia



83 Potovio

INDEX

Prehled sortimentu podle materiálu
 Prehľad sortimentu podľa materiálov
 Przegląd produktów według materiału
 Anyagok szerint rendezett termékáttekintő

 84 Barcino	 87 Gissi	 92 Meduno	 100 Galleno	Hliník Hliník Aluminium Aluminium	
 84 Bracara	 87 Osimo	 92 Flavia	 100 Fossa		 7 Apua
 84 Olisipo	 89 Egara	 92 Emo	 100 Solva		 7 Nubia
 85 Arezzo	 89 Bruxella	 93 Bevipo	 101 Altedo		 8 Torino
 85 Topeka	 90 Salacia	 93 Dipo	 101 Larru		 8 Velitra
 86 Siradia	 90 Eburaco	 98 Lorica			 9 Capua
 86 Sertao	 90 Savelli	 98 Matane			 9 Imperia
 87 Haida	 90 Salemi	 99 Essa			 15 Clivia
 87 Terranda	 91 Alberta	 99 Tonala			 19 Kervo



20 Stabia



21 Rovigo



22/23 Canis L



24/25 Canis C



29 Trani



29 Ticinum



31 Lamezia



32 Lindavia



32 Lutetia



32 Eslinga



32 Seveso



33 Mosena



34 Rianza



66 Naila



66 Culmen



70 Catana



74 Codania



91 Ogulin

Hliník a zinek
Hliník a zinok
Aluminium i cynk
Alumínium és cink



11 Bermeo



35 Capris



36 Nidum



36 Spira



57 Borgoa

Nerezová ocel
Nerezová ocel'
Stal nierdzewna
Nemesacél



6 Tempe



13 Anzio



13 Arnum



14 Aratti



14 Aosta



16 Pola



16 Guarani



16 Narona



18 Salvia



30 Narni



37 Apolda



38 Onex



38 Agrinum



38 Monacum



39 Danum



39 Sion



39 Spalatum

INDEX

Prehľad sortimentu podľa materiálu
 Prehľad sortimentu podľa materiálov
 Przegląd produktów według materiału
 Anyagok szerint rendezett termékáttekintő



47 Ponte



58 Aboa



67 Vada



69 Asopus



75 Sipontum



77 Serbinum



98 Dodona

Mosz
 Mosadz
 Mosiádz
 Sárgaréz



30 Empoli

Nerez a zinek
 Nerezová oceľ a zinok
 Stal nierdzewna i cynk
 Nemesacél és cink



44 Brema



45 Como

Oceľ a nerez
 Oceľ a nerezová oceľ
 Stal i stal nierdzewna
 Acél és nemesacél



47 Cecina

Zinek a plast
 Zinok a plast
 Cynk i tworzywo sztuczne
 Cink és műanyag



103 Touch-in



103 Touch-in

Kůže
 Koža
 Skóra
 Bőr



95 Gela



95 Galati



96 Nica

Kůže a oceľ
 Koža a oceľ
 Skóra i stal
 Bőr és acél



94 Byzantia

Kůže a mosaz
 Koža a mosadz
 Skóra i mosiádz
 Bőr és sárgaréz



96 Filaga

Kůže a zinek
 Koža a zinok
 Skóra i cynk
 Bőr és cink



97 Agna



97 Agliano



97 Dublinia

Kůže a nerez
 Koža a nerezová oceľ
 Skóra i stal nierdzewna
 Bőr és nemesacél



94 Getafe

Kůže, drevo a zinek
 Koža, drevo a zinok
 Skóra, drewno i cynk
 Bőr, fa és cink



97 Arago

Rejstřík
Register
Alfabetyczny spis artykułów
Szakszójegyzék

Aboa	58	Corduba	82	Matilo	62	Spalatum	39
Agliano	97	Coria	59	Meana	73	Spira	36
Agna	97	Culmen	66	Meduno	92	Stabia	20
Agrinum	38	Danum	39	Messana	27	Suasa	72
Alberta	91	Delia	51	Milo	28	Tardiano	75
Almus	76	Dinia	65	Misnia	37	Tarraco	83
Altedo	101	Dipo	93	Monacum	38	Tempe	6
Alvito	16	Dodona	98	Mosena	33	Terranda	87
Amisia	42	Dublina	97	Naila	66	Ticinum	29
Anzio	13	Eburaco	90	Narni	30	Tolfo	56
Aosta	14	Egara	89	Narona	16	Tolosa	65
Apolda	37	Emo	92	Neapolis	56	Tonala	99
Apua	7	Empoli	30	Nica	96	Topeka	85
Arago	97	Eslinga	32	Nicia	61	Torino	8
Aratti	14	Essa	99	Nidum	36	Tornea	12
Arezzo	85	Evisa	9	Novae	38	Touch-in	103
Arimini	50	Fectio	64	Nubia	7	Trani	29
Arnum	13	Felina	58	Nursia	11	Trento	73
Asopus	69	Fermo	19	Ogulin	91	Utinum	45
Athena	56	Filaga	96	Oka	82	Vada	67
Avenio	68	Flavia	92	Olisipo	84	Valentia	88
Baldone	46	Fogo	53	Olivia	57	Vantania	64
Balmo	60	Forli	44	Onex	38	Velitra	8
Barcino	84	Fossa	100	Opera	50	Venusia	28
Basilia	49	Galati	95	Osimo	87	Veronia	49
Bathia	62	Galleno	100	Ovada	63	Vesontio	82
Belluno	46	Gela	95	Parma	59	Vieste	71
Belna	69	Genoa	26	Pola	16	Vigilia	6
Bermeo	11	Genzone	35	Pomezia	83	Zenga	10
Bevipo	93	Getafe	94	Ponoka	82		
Bona	53	Gissi	87	Ponte	47		
Borgoa	57	Guarani	16	Ponti	81		
Bracara	84	Haida	87	Ponzone	81		
Brema	44	Hale	17	Potovio	83		
Bruxella	89	Imperia	9	Rialto	27		
Byzantia	94	Intra	48	Riaza	34		
Calili	80	Issa	75	Rovigo	21		
Canis C	24/25	Istrana	43	Sala	76		
Canis L	22/23	Itri	43	Salacia	90		
Capris	35	Kervo	19	Salemi	90		
Capua	9	Ladera	75	Salona	63		
Carolina	72	Lamezia	31	Salvia	18		
Carvo	60	Larru	101	Saturnia	50		
Catana	70	Limpio	42	Sava	51		
Cato	80	Lindavia	32	Savelli	90		
Cecina	47	Lodi	51	Serbinum	77		
Celista	26	Londa	52	Sertao	86		
Chalcis	71	Lorica	98	Seveso	32		
Cheam	12	Lucca	70	Sion	39		
Cirpi	77	Luro	83	Sipontum	75		
Clivia	15	Lutetia	32	Siradia	86		
Codania	74	Malaca	88	Solda	52		
Como	45	Matane	98	Solva	100		

INDEX

Seznam objednacích čísel

Zoznam objednávacích čísel

Wykaz numerów artykułów

Rendelési számok jegyzéke

0 020 014	113	0 115 081	70	0 115 360	15	9 069 909	68	9 070 448	68
0 043 472	60	0 115 090	32	0 115 361	15	9 069 915	68	9 070 451	67
0 043 502	46	0 115 091	32	0 115 362	15	9 069 919	68	9 070 457	67
0 043 503	46	0 115 115	32	0 115 363	15	9 069 922	68	9 070 466	67
0 043 505	46	0 115 122	56	0 115 364	15	9 069 927	68	9 070 481	67
0 043 506	46	0 115 127	37	0 115 365	111	9 069 942	69	9 070 492	62
0 043 642	46	0 115 146	66	0 115 366	111	9 069 943	68	9 070 493	62
0 043 643	46	0 115 147	66	0 115 374	84	9 070 025	68	9 070 494	67
0 044 763	113	0 115 148	66	0 115 385	47	9 070 030	68	9 070 501	67
0 044 764	113	0 115 149	66	0 115 387	47	9 070 054	68	9 070 504	67
0 044 765	113	0 115 150	66	1 160 018	13	9 070 075	68	9 070 508	62
0 044 766	113	0 115 152	66	1 160 019	13	9 070 078	68	9 070 509	67
0 044 767	113	0 115 153	66	1 160 020	13	9 070 095	73	9 070 510	88
0 046 700	110	0 115 154	28	1 160 021	13	9 070 096	69	9 070 511	68
0 048 771	116	0 115 155	28	1 160 022	13	9 070 101	69	9 070 512	68
0 070 263	113	0 115 156	27	1 160 023	13	9 070 102	69	9 070 513	88
0 070 264	113	0 115 157	27	1 160 024	13	9 070 103	69	9 070 516	62
0 070 266	113	0 115 169	69	1 160 025	13	9 070 104	44	9 070 519	68
0 071 544	110	0 115 170	69	1 170 155	63	9 070 105	69	9 070 520	53
0 071 545	110	0 115 181	37	1 170 158	64	9 070 106	44	9 070 521	68
0 071 546	110	0 115 182	37	1 170 173	92	9 070 107	44	9 070 522	68
0 071 547	110	0 115 183	37	9 064 670	9	9 070 108	44	9 070 523	53
0 071 548	110	0 115 195	62	9 064 671	9	9 070 109	44	9 070 527	68
0 071 549	110	0 115 203	65	9 064 819	7	9 070 110	44	9 070 540	68
0 071 555	110	0 115 205	15	9 064 820	7	9 070 111	69	9 070 548	68
0 071 556	110	0 115 206	15	9 065 425	56	9 070 112	44	9 070 552	68
0 071 557	110	0 115 207	15	9 065 426	56	9 070 113	44	9 070 556	57
0 071 558	110	0 115 208	15	9 065 427	56	9 070 117	69	9 070 557	68
0 071 559	110	0 115 209	15	9 065 611	26	9 070 118	69	9 070 562	77
0 071 560	110	0 115 210	15	9 065 612	26	9 070 119	69	9 070 565	57
0 071 561	110	0 115 211	15	9 065 627	6	9 070 120	69	9 070 567	57
0 071 562	110	0 115 212	15	9 065 628	6	9 070 121	73	9 070 568	75
0 071 563	110	0 115 213	15	9 065 634	49	9 070 122	69	9 070 572	68
0 071 855	110	0 115 214	15	9 065 635	49	9 070 123	73	9 070 574	57
0 071 856	110	0 115 215	15	9 069 804	14	9 070 124	69	9 070 575	100
0 074 134	60	0 115 216	15	9 069 805	14	9 070 125	73	9 070 577	68
0 115 014	8	0 115 217	15	9 069 806	14	9 070 138	58	9 070 580	39
0 115 016	8	0 115 218	15	9 069 807	14	9 070 142	94	9 070 581	77
0 115 017	8	0 115 263	93	9 069 808	14	9 070 143	94	9 070 583	29
0 115 018	8	0 115 264	93	9 069 815	69	9 070 144	94	9 070 585	77
0 115 019	19	0 115 266	82	9 069 818	69	9 070 147	94	9 070 586	77
0 115 020	19	0 115 292	92	9 069 821	69	9 070 148	94	9 070 588	29
0 115 021	20	0 115 293	92	9 069 865	69	9 070 149	94	9 070 589	77
0 115 022	20	0 115 298	36	9 069 867	68	9 070 263	38	9 070 593	29
0 115 023	20	0 115 312	75	9 069 868	68	9 070 264	38	9 070 602	68
0 115 024	20	0 115 314	36	9 069 873	68	9 070 420	69	9 070 605	68
0 115 028	35	0 115 353	15	9 069 877	68	9 070 421	69	9 070 619	68
0 115 049	35	0 115 354	15	9 069 890	44	9 070 429	68	9 070 624	59
0 115 060	47	0 115 355	15	9 069 892	68	9 070 439	68	9 070 625	68
0 115 076	49	0 115 356	15	9 069 893	44	9 070 440	67	9 070 674	17
0 115 077	45	0 115 357	15	9 069 899	68	9 070 443	68	9 070 675	65
0 115 078	45	0 115 358	15	9 069 900	68	9 070 444	68	9 070 681	65
0 115 080	70	0 115 359	15	9 069 907	68	9 070 446	67	9 070 693	98

9 070 722	61	9 070 985	61	9 071 068	61	9 086 701	105	9 106 169	7
9 070 723	61	9 070 986	61	9 071 071	36	9 086 702	105	9 109 703	45
9 070 732	17	9 070 988	18	9 071 073	36	9 097 899	56	9 112 583	76
9 070 733	17	9 070 991	18	9 071 075	36	9 097 900	56	9 112 588	76
9 070 734	17	9 070 992	16	9 071 079	36	9 097 946	49	9 112 590	76
9 070 735	39	9 070 993	18	9 071 082	36	9 097 947	49	9 112 591	90
9 070 736	17	9 070 995	16	9 071 109	76	9 097 950	27	9 112 594	90
9 070 738	17	9 070 996	18	9 071 110	76	9 097 953	27	9 112 595	59
9 070 740	39	9 070 997	61	9 071 111	18	9 105 735	48	9 112 596	59
9 070 742	17	9 070 998	16	9 071 112	18	9 105 737	48	9 112 597	59
9 070 743	17	9 070 999	18	9 071 115	18	9 105 742	10	9 112 599	100
9 070 744	39	9 071 000	16	9 071 116	18	9 105 743	10	9 112 600	84
9 070 746	17	9 071 001	61	9 071 118	18	9 105 746	10	9 112 601	83
9 070 747	17	9 071 003	18	9 071 120	18	9 105 747	10	9 112 607	83
9 070 750	17	9 071 005	18	9 071 718	89	9 105 793	28	9 112 613	64
9 070 751	17	9 071 008	18	9 071 719	89	9 105 794	28	9 112 615	64
9 070 752	65	9 071 009	18	9 071 720	89	9 105 801	31	9 112 619	89
9 070 753	17	9 071 010	16	9 071 836	96	9 105 802	31	9 112 623	60
9 070 754	65	9 071 012	18	9 071 837	96	9 105 803	31	9 112 631	84
9 070 755	17	9 071 013	16	9 071 838	96	9 105 805	31	9 112 632	84
9 070 756	17	9 071 014	61	9 071 839	96	9 105 806	31	9 112 633	38
9 070 758	17	9 071 016	61	9 071 840	96	9 105 807	31	9 112 634	38
9 070 759	17	9 071 017	18	9 071 841	96	9 105 809	31	9 112 635	82
9 070 763	17	9 071 018	61	9 071 842	96	9 105 810	31	9 112 637	11
9 070 765	17	9 071 019	61	9 071 843	96	9 105 811	31	9 112 644	75
9 070 784	61	9 071 020	18	9 071 844	96	9 105 813	31	9 112 646	100
9 070 796	17	9 071 021	18	9 071 869	16	9 105 815	31	9 112 650	83
9 070 803	17	9 071 023	18	9 071 926	8	9 105 816	31	9 112 651	87
9 070 807	17	9 071 024	18	9 071 927	8	9 105 819	31	9 112 652	84
9 070 809	17	9 071 026	18	9 071 929	8	9 105 820	31	9 112 653	90
9 070 811	17	9 071 027	18	9 071 930	8	9 105 821	31	9 112 654	90
9 070 813	17	9 071 030	18	9 077 861	111	9 105 822	31	9 112 655	98
9 070 816	17	9 071 037	61	9 080 838	26	9 105 823	31	9 112 660	44
9 070 817	17	9 071 038	18	9 080 850	82	9 105 824	31	9 112 662	92
9 070 821	17	9 071 039	61	9 080 851	82	9 105 825	31	9 112 664	50
9 070 825	17	9 071 041	19	9 080 852	82	9 105 826	31	9 112 666	9
9 070 943	88	9 071 042	18	9 080 853	82	9 105 827	31	9 112 667	9
9 070 945	88	9 071 043	18	9 080 858	72	9 105 828	31	9 112 672	7
9 070 957	38	9 071 045	18	9 080 859	72	9 105 829	31	9 112 674	7
9 070 958	38	9 071 046	18	9 082 136	26	9 105 830	31	9 112 909	65
9 070 967	18	9 071 048	18	9 082 137	26	9 105 831	31	9 112 910	65
9 070 970	16	9 071 049	61	9 086 687	103	9 105 832	31	9 112 914	62
9 070 972	18	9 071 050	18	9 086 688	103	9 105 833	31	9 112 915	72
9 070 973	16	9 071 051	18	9 086 689	103	9 105 834	31	9 112 916	72
9 070 975	16	9 071 052	18	9 086 690	103	9 105 835	31	9 112 938	12
9 070 976	61	9 071 053	18	9 086 691	104	9 105 836	31	9 112 940	12
9 070 977	16	9 071 054	18	9 086 692	104	9 105 837	7	9 112 941	12
9 070 978	18	9 071 055	18	9 086 693	104	9 105 838	7	9 112 943	12
9 070 979	16	9 071 056	18	9 086 694	104	9 105 839	7	9 113 179	91
9 070 980	61	9 071 058	18	9 086 695	105	9 105 840	7	9 113 180	91
9 070 982	18	9 071 060	36	9 086 696	105	9 106 166	7	9 113 181	91
9 070 983	61	9 071 063	61	9 086 697	105	9 106 167	7	9 113 182	71
9 070 984	18	9 071 067	61	9 086 698	105	9 106 168	7	9 113 183	71

INDEX

Seznam objednacích čísel

Zoznam objednávacích čísel

Wykaz numerów artykułów

Rendelési számok jegyzéke

9 113 210	64	9 113 635	16	9 190 399	66	9 204 159	20	9 208 027	86
9 113 211	64	9 113 645	95	9 190 421	66	9 204 160	20	9 208 030	80
9 113 212	12	9 113 646	95	9 190 422	66	9 204 161	20	9 208 046	16
9 113 220	99	9 113 647	95	9 190 423	66	9 204 162	20	9 208 047	16
9 113 221	99	9 113 648	95	9 190 424	66	9 204 163	20	9 208 048	16
9 113 222	99	9 113 649	95	9 190 425	66	9 204 164	13	9 208 049	16
9 113 223	99	9 113 650	95	9 190 426	66	9 204 175	13	9 208 064	86
9 113 224	53	9 113 651	110	9 190 427	66	9 204 177	13	9 208 065	86
9 113 225	87	9 113 652	110	9 190 428	66	9 204 195	21	9 208 068	80
9 113 227	87	9 113 653	110	9 190 429	66	9 204 196	21	9 208 070	14
9 113 228	98	9 113 654	110	9 190 430	66	9 204 197	21	9 208 071	13
9 113 247	14	9 113 659	101	9 190 431	66	9 206 115	66	9 208 072	13
9 113 248	14	9 113 675	50	9 190 432	66	9 206 116	66	9 208 073	11
9 113 250	14	9 113 678	50	9 190 433	66	9 206 117	66	9 208 074	11
9 113 251	14	9 113 681	50	9 190 434	66	9 206 119	66	9 208 075	11
9 113 252	14	9 113 685	51	9 190 435	66	9 206 120	66	9 208 076	11
9 113 255	14	9 113 690	51	9 190 436	19	9 206 122	66	9 208 077	11
9 113 257	14	9 113 691	96	9 190 437	19	9 206 124	66	9 208 078	11
9 113 258	14	9 113 694	96	9 190 438	19	9 206 126	84	9 208 079	11
9 113 286	100	9 113 696	51	9 190 439	19	9 206 127	84	9 208 080	11
9 113 292	87	9 113 699	51	9 190 440	19	9 206 128	84	9 208 081	11
9 113 293	101	9 113 700	51	9 190 441	19	9 206 129	84	9 208 082	11
9 113 297	21	9 113 712	50	9 190 442	19	9 206 130	84	9 208 083	11
9 113 298	21	9 113 719	50	9 190 443	19	9 206 131	84	9 208 084	11
9 113 299	21	9 113 733	70	9 190 444	19	9 206 132	100	9 208 085	11
9 113 300	21	9 113 734	70	9 190 445	42	9 206 133	100	9 208 086	11
9 113 327	87	9 113 800	48	9 190 446	42	9 206 134	81	9 208 087	11
9 113 347	111	9 114 036	76	9 191 722	6	9 206 136	81	9 208 088	11
9 113 368	90	9 114 539	73	9 191 745	37	9 206 137	83	9 208 089	34
9 113 371	58	9 114 747	56	9 194 367	19	9 206 138	83	9 208 090	34
9 113 373	58	9 118 517	63	9 194 368	19	9 206 237	83	9 208 091	34
9 113 397	51	9 118 518	63	9 199 030	47	9 206 239	83	9 208 092	34
9 113 404	51	9 118 520	63	9 199 091	47	9 206 642	62	9 208 093	34
9 113 429	81	9 118 521	63	9 199 092	47	9 206 738	77	9 208 094	34
9 113 430	81	9 118 523	63	9 199 093	47	9 206 741	30	9 208 095	34
9 113 444	87	9 118 524	63	9 203 958	75	9 207 348	13	9 208 097	34
9 113 445	87	9 118 858	44	9 203 963	16	9 207 349	13	9 208 098	34
9 113 451	97	9 120 134	20	9 204 022	21	9 207 350	13	9 208 099	34
9 113 453	97	9 120 199	11	9 204 023	21	9 207 351	13	9 208 100	34
9 113 454	97	9 131 319	94	9 204 024	21	9 207 352	13	9 208 101	34
9 113 467	59	9 131 320	94	9 204 025	21	9 207 354	13	9 208 102	34
9 113 468	59	9 131 321	94	9 204 026	21	9 207 356	13	9 208 103	34
9 113 483	90	9 131 322	94	9 204 027	21	9 207 357	14	9 208 551	8
9 113 501	9	9 131 323	94	9 204 028	21	9 207 358	14	9 208 578	8
9 113 502	9	9 131 324	94	9 204 029	21	9 207 452	97	9 208 579	8
9 113 508	97	9 131 455	29	9 204 030	21	9 207 480	48	9 208 580	8
9 113 509	97	9 132 312	43	9 204 031	21	9 207 481	48	9 209 058	20
9 113 510	70	9 132 314	43	9 204 032	21	9 207 482	48	9 209 059	20
9 113 511	70	9 145 262	35	9 204 033	21	9 207 483	48	9 209 060	20
9 113 514	65	9 145 263	35	9 204 136	76	9 207 488	44	9 209 061	20
9 113 564	39	9 149 293	35	9 204 153	101	9 207 531	37	9 209 062	20
9 113 565	38	9 149 296	35	9 204 157	20	9 207 534	58	9 209 063	20
9 113 594	96	9 158 400	30	9 204 158	20	9 208 026	86	9 209 064	20

9 209 994	74	9 264 087	11	9 265 993	31	9 266 420	85	9 995 123	32
9 209 995	74	9 264 088	48	9 265 994	31	9 266 561	99	9 995 437	29
9 209 996	74	9 265 879	15	9 265 997	74	9 266 562	91	9 995 438	29
9 209 997	74	9 265 880	15	9 265 998	74	9 266 563	91	9 995 439	29
9 210 058	74	9 265 885	75	9 265 999	74	9 266 564	91	9 995 440	29
9 210 059	74	9 265 886	101	9 266 000	74	9 266 565	91	9 995 480	46
9 210 060	74	9 265 887	58	9 266 001	74	9 266 566	83	9 995 481	46
9 210 061	74	9 265 888	15	9 266 002	74	9 266 567	83	9 995 482	46
9 210 062	74	9 265 921	15	9 266 003	74	9 266 568	83	9 995 483	46
9 210 063	74	9 265 922	15	9 266 004	74	9 268 219	12	9 995 484	46
9 210 115	22	9 265 923	15	9 266 005	74	9 268 262	12	9 995 485	46
9 210 116	22	9 265 924	15	9 266 006	74	9 269 731	12	9 995 497	71
9 210 117	22	9 265 925	15	9 266 067	74	9 269 732	12	9 995 498	71
9 210 119	22	9 265 926	15	9 266 068	74	9 269 733	46	9 995 499	71
9 210 122	23	9 265 927	15	9 266 069	74	9 269 734	46	9 995 500	71
9 210 125	23	9 265 928	15	9 266 070	74	9 269 735	46	9 995 501	71
9 210 126	23	9 265 929	15	9 266 071	74	9 269 736	46	9 995 540	30
9 210 128	23	9 265 930	15	9 266 072	74	9 269 741	52	9 995 541	30
9 210 129	23	9 265 931	15	9 266 073	74	9 269 742	52	9 995 542	30
9 210 129	25	9 265 932	15	9 266 074	74	9 270 230	85	9 995 546	46
9 210 130	24	9 265 933	15	9 266 075	74	9 270 437	46	9 995 547	46
9 210 132	24	9 265 934	15	9 266 076	74	9 270 438	46	9 995 548	46
9 210 133	24	9 265 935	15	9 266 077	66	9 270 439	46	9 995 574	30
9 210 136	24	9 265 936	15	9 266 078	66	9 277 179	57	9 995 585	9
9 210 138	25	9 265 937	15	9 266 079	66	9 282 776	19	9 995 586	9
9 210 139	25	9 265 938	15	9 266 080	66	9 303 227	29	9 995 587	9
9 210 140	25	9 265 939	15	9 266 091	66	9 303 228	29	9 995 588	9
9 210 141	25	9 265 940	15	9 266 092	66	9 303 229	29	9 995 589	9
9 210 142	23	9 265 941	15	9 266 093	66	9 306 610	68	9 995 590	9
9 210 142	25	9 265 942	15	9 266 094	66	9 306 926	68	9 995 771	46
9 210 143	23	9 265 943	15	9 266 095	34	9 306 927	68	9 995 772	46
9 210 143	25	9 265 949	29	9 266 096	34	9 306 928	68	9 995 773	46
9 212 860	110	9 265 950	29	9 266 097	34	9 306 929	68	9 995 780	46
9 237 970	33	9 265 971	29	9 266 098	34	9 306 930	68	9 995 781	46
9 252 428	12	9 265 972	29	9 266 099	34	9 306 941	68	9 995 782	46
9 252 429	12	9 265 973	31	9 266 100	34	9 306 942	68		
9 252 430	12	9 265 975	31	9 266 101	34	9 306 943	68		
9 260 744	98	9 265 976	31	9 266 102	34	9 306 944	68		
9 264 060	85	9 265 977	31	9 266 104	22	9 306 945	61		
9 264 072	45	9 265 978	31	9 266 105	22	9 306 946	61		
9 264 073	45	9 265 979	31	9 266 106	23	9 306 947	61		
9 264 074	44	9 265 980	31	9 266 107	23	9 306 948	61		
9 264 075	44	9 265 981	31	9 266 132	24	9 306 949	61		
9 264 076	44	9 265 982	31	9 266 133	24	9 306 950	17		
9 264 077	44	9 265 983	31	9 266 134	25	9 306 951	17		
9 264 078	44	9 265 985	31	9 266 135	25	9 306 952	17		
9 264 079	44	9 265 986	31	9 266 141	75	9 306 953	17		
9 264 080	44	9 265 987	31	9 266 142	75	9 306 954	17		
9 264 081	44	9 265 988	31	9 266 415	57	9 306 955	17		
9 264 082	44	9 265 989	31	9 266 416	57	9 306 956	17		
9 264 084	44	9 265 990	31	9 266 417	42	9 306 958	17		
9 264 085	44	9 265 991	31	9 266 418	42	9 306 959	17		
9 264 086	27	9 265 992	31	9 266 419	85	9 995 122	32		

Impressum:

© Hettich Marketing- und Vertriebs GmbH & Co. KG
Gerhard-Lüking-Str. 10
32602 Vlotho, Německo

Pro tento katalog si vyhrazujeme veškerá autorská práva vyplývající z platných zákonů. Bez našeho souhlasu není dovoleno jakýmkoliv způsobem kopírovat katalog nebo jeho části. Technické změny vyhrazeny. Neručíme za tiskové chyby nebo překlepy. Odchylky vyobrazených barev od skutečnosti vyhrazeny.

Březen 2022

Impressum:

© Hettich Marketing- und Vertriebs GmbH & Co. KG
Gerhard-Lüking-Str. 10
32602 Vlotho, Nemecko

Pre tento katalóg si vyhradujeme všetky autorské práva. Bez nášho písomného súhlasu je akákoľvek reprodukcia katalógu alebo jeho častí zakázaná. Technické zmeny vyhradené. Neručíme za tlačové chyby alebo preklepy. Odlišnosti farebného tónu vyhradené.

Marec 2022

Metryka:

© Hettich Marketing- und Vertriebs GmbH & Co. KG
Gerhard-Lüking-Str. 10
32602 Vlotho, Niemcy

Zastrzegamy sobie wszelkie prawa do niniejszego katalogu wynikające z prawa autorskiego. Bez uzyskania naszej pisemnej zgody zabrania się kopiowania w dowolnej formie zarówno całego katalogu, jak i jego części. Zmiany techniczne zastrzeżone. Nie przejmujemy odpowiedzialności za błędy w druku lub omyłki. Przedstawione kolory mogą odbiegać od rzeczywistości.

Marzec 2022

Impresszum:

© Hettich Marketing- und Vertriebs GmbH & Co. KG
Gerhard-Lüking-Str. 10
32602 Vlotho, Németország

Fenntartjuk a jelen katalógus minden szerzői jogát. Írásbeli engedélyünk nélkül tilos a katalógus és részei sokszorosítása. Fenntartjuk a műszaki változtatások jogát. Nem vállalunk garanciát nyomdahibákért és tévedésekért. Fenntartjuk a színelterések jogát.

2022. március

Poznejte blíže rodinný podnik
Hettich!

Spoznajte bližšie rodinný podnik
Hettich!

Poznajte bliżej rodzinne
przedsiębiorstwo Hettich!

Ismerje meg a családi tulajdonban
lévő Hettich vállalatot!

